



National Aeronautics
and Space Administration

Education Product

Teachers

Grades 5–12

SUITED FOR SPACEWALKING

A Teacher's Guide with Activities for
Technology Education, Mathematics, and Science



Suited for Spacewalking—A Teacher's Guide with Activities for Technology Education, Mathematics, and Science is available in electronic format through NASA Spacelink—one of the Agency's electronic resources specifically developed for use by the educational community.

The system may be accessed at the following address:
<http://spacelink.nasa.gov>

Suited for Spacewalking

A Teacher's Guide with Activities for Technology
Education, Mathematics, and Science



National Aeronautics and Space Administration

Office of Human Resources and Education
Education Division
Washington, DC



Education Working Group
NASA Johnson Space Center
Houston, Texas

This publication is in the Public Domain and is not protected by copyright.
Permission is not required for duplication.

EG-1998-03-112-HQ

Acknowledgments

This publication was developed for the National Aeronautics and Space Administration by:

Writer/Illustrator:

Gregory L. Vogt, Ed.D.
Crew Educational Affairs Liaison
Teaching From Space Program
NASA Johnson Space Center
Houston, TX

Editor:

Jane A. George
Educational Materials Specialist
Teaching From Space Program
NASA Headquarters
Washington, DC

Reviewers:

Linda Godwin
NASA Astronaut
NASA Johnson Space Center

Joseph J. Kosmo
Senior Project Engineer
EVA and Spacesuit Systems Branch
NASA Johnson Space Center

Philip R. West
Project Manager, EVA Tools
for the International Space Station
NASA Johnson Space Center

Cathy A. Gardner
Teacher Intern, Teaching From Space
Silbernagel Elementary School
Dickenson, Texas

Deborah A. Shearer
Science Teacher
Zue S. Baales Intermediate School
Friendswood, Texas

Sandy Peck
Clear Creek Independent School District
League City, Texas

Marilyn L. Fowler, Ph.D.
Science Project Specialist
Charles A. Dana Center
University of Texas at Austin

Jeanne Gasiorowski
Manager, NASA Educator Resource Center
Classroom of the Future
Wheeling Jesuit University
Wheeling, West Virginia

Dr. Peggy House
Director, The Glenn T. Seaborg
Center for Teaching and Learning
Science and Mathematics
Northern Michigan University

Doris K. Grigsby, Ed.D.
AESP Management and Performance
Specialist for Training
Oklahoma State University

Flint Wild
Technology Specialist
Teaching From Space Program
Oklahoma State University

Patterson A. Biggs
Angelo A. Casaburri
Eva J. Farley
James E. Pratt
Joan Sanders
Aerospace Education Specialists
Oklahoma State University



Table of Contents

National Education Standards	1
Introduction	5
Earth and Space	7
The Outer Space Environment	9
Spacewalking History	11
The Space Shuttle EMU	17
Working In Space	31
EVAs on the International Space Station	37
Future Spacesuits	39
Activities	
Designing Spacesuits for Mars	43
Introduction	44
Design Brief	47
Interface Control Document (Master)	49
Interface Control Document (Sample)	50
Teacher Tech Briefs	51
Exploration Briefs	63
Idea Bank	89
Glossary	95
References	97
NASA Educational Resources	99
Go for EVA!	101
Evaluation Reply Card	Insert



National Education Standards

The activities set forth in this curriculum supplement address national standards for science and mathematics, and the universals of technology for technology education. The matrices that follow specifically identify the standards by activity. The standards for science and mathematics in grades 4–8 and 9–12 have been combined.



Universals of Technology

International Technology Education Association, 1996*

Class Project
Tensile Strength Test Stand
Impact Resistance Tester
Abrasion Tester
Different Gravity
Meteoroids and Space Debris
Keeping Your Cool
Absorption and Radiation
Getting the Right Fit
O—How Much?
Keeping the Pressure On
Bending Under Pressure

Technological Processes

- Technological design
- Developing and Producing Technological Systems
- Utilizing and Managing Technological Systems
- Assessing the Impact and Consequences of Technological Systems

✓	✓	✓	✓			✓		✓	✓	✓	✓
✓	✓	✓	✓	✓		✓				✓	✓
✓					✓	✓	✓	✓	✓	✓	✓

Technological Knowledge

- Technological Concepts and Principles
- Nature and Listing of Technology
- Linkages

✓										✓	✓
✓	✓	✓	✓			✓					
✓					✓		✓		✓	✓	✓

Technological Contexts

- Informational Systems
- Physical Systems
- Biological and Chemical Systems

✓	✓	✓	✓								
✓	✓	✓	✓		✓	✓	✓	✓	✓	✓	✓
✓					✓	✓		✓			

*The Standards for Technology Education are still under development



National Science Education Standards

National Research Council, 1996
Grades 4–12



Class Project
Tensile Strength Test Stand
Impact Resistance Tester
Abrasion Tester
Different Gravity
Meteoroids and Space Debris
Keeping Your Cool
Absorption and Radiation
Getting the Right Fit
O—How Much?
Keeping the Pressure On
Bending Under Pressure

Science as Inquiry

- Abilities Necessary to do Scientific Inquiry

✓	✓	✓	✓		✓		✓		✓				
---	---	---	---	--	---	--	---	--	---	--	--	--	--

Physical Science

- Properties and Changes of Properties in Matter
- Motions and Forces
- Transfer of Energy
- Interactions of Energy and Matter

✓	✓	✓	✓		✓								
---	---	---	---	--	---	--	--	--	--	--	--	--	--

✓	✓	✓	✓	✓							✓	✓	
✓	✓	✓	✓		✓	✓	✓						
✓	✓	✓	✓		✓	✓	✓				✓	✓	

Life Science

- Structure and Function in Living Systems

✓										✓			
---	--	--	--	--	--	--	--	--	--	---	--	--	--

Earth and Space Science

- Earth in the Solar System

✓													
---	--	--	--	--	--	--	--	--	--	--	--	--	--

Science and Technology

- Abilities of Technological Design
- Understanding about Science and Technology

✓	✓	✓	✓								✓	✓	
✓	✓	✓	✓				✓	✓			✓	✓	

Science in Personal and Social Perspectives

- Populations, Resources, and Environments
- Risks and Benefits
- Natural and Human-Induced Hazards

✓													
---	--	--	--	--	--	--	--	--	--	--	--	--	--

✓		✓			✓								
✓		✓			✓								



National Mathematics Standards

National Council of Teachers of Mathematics, 1989

Grades 4–12



Class Project
 Tensile Strength Test Stand
 Impact Resistance Tester
 Abrasion Tester
 Different Gravity
 Meteoroids and Space Debris
 Keeping Your Cool
 Absorption and Radiation
 Getting the Right Fit
 O—How Much?
 Keeping the Pressure On
 Bending Under Pressure

Mathematics as Problem Solving
 Mathematics as Communication
 Mathematics as Reasoning
 Mathematical Connection
 Computation and Estimation
 Algebra
 Geometry
 Measurement

✓	✓	✓	✓		✓		✓	✓	✓		✓
✓	✓	✓	✓		✓		✓	✓	✓		✓
✓	✓	✓									
✓	✓	✓			✓			✓			
✓	✓	✓					✓		✓		
✓	✓	✓					✓	✓			✓
✓	✓	✓	✓				✓	✓	✓		



Introduction

Spacewalking has captured the imagination of generations of children and adults since science-fiction authors first placed their characters on the Moon. But true spacewalking did not actually begin until the mid-1960s with the exploits of Alexei A. Leonov of the Soviet Union and Edward H. White II of the United States. Since those first tentative probings outside a space capsule, astronauts and cosmonauts have logged thousands of hours on extravehicular activities, and some have even walked on the surface of the Moon. The stories of their missions in space are fascinating, but just as interesting is the spacesuit technology that made it possible for them to “walk” in space.

Today, spacesuits are used by astronauts on many missions such as servicing the Hubble Space Telescope and retrieving satellites. The new International Space Station will depend upon astronauts and cosmonauts to conduct over 1,200 hours of spacewalks over the next several years to assemble and maintain Space Station components. Although no firm plans exist, NASA hopes to return to the Moon to establish a permanent base and later begin human surface exploration of Mars. Each of these ventures places distinct demands on spacesuits systems and the tools astronauts use.

This publication serves as a guide for technology education teachers. While not specifically aimed

at other subject areas, teachers of physical science and mathematics will find the Exploration Briefs and the Idea Bank useful as a source of activity ideas.

The guide begins with brief discussions of the space environment, the history of spacewalking, NASA's current spacesuit, and work that astronauts do during spacewalks. These are followed by a technology education design brief that challenges students to design and build a spacesuit prototype for an extraterrestrial environment no human has ever visited before. In the process of doing this, students will have to investigate the properties of that environment and determine what protective measures must be taken to permit a future explorer to work there safely. Once accomplished, students will choose materials and technologies that can be used for constructing and testing the prototype. The design brief is followed by Teacher Tech Briefs that provide a source of ideas on how to build spacesuit test apparatus and by Exploration Briefs that provide activity frameworks to help students understand important topics in spacesuit design.

The guide concludes with a glossary of terms, suggested reading list, NASA educational resources including electronic resources, and an evaluation questionnaire. We would appreciate your assistance in improving this guide in future editions by completing the feedback questionnaire electronically or mailing the form to us.



Measurement

This activity guide makes use of the metric system for measurement. However, British units for measurement may be listed in materials and tools lists when particular items are more easily found in British measurement sizes. The pascal or metric

unit for pressure may be unfamiliar to readers. A *pascal* is equal to a force of one newton exerted over an area of one square meter. Because the pascal is a relatively small unit, the more convenient unit of kilopascal (1,000 pascals) is used here instead. To convert kilopascals to the British-system unit of pounds per square inch, divide by 6.895.



Earth and Space

If we define an astronaut as someone who travels through space, everyone on Earth is an astronaut. Even though we may be standing still on Earth's surface, we are actually traveling through space at speeds of thousands of kilometers per hour. Indeed, our planet may be thought of as a spaceship on a never-ending voyage. As "astronauts" traveling through space on the surface of Earth, we take for granted the complex environment that sustains life. Earth's gravitational attraction holds a dense atmosphere of nitrogen, oxygen, carbon dioxide, and water vapor in a thick envelope surrounding Earth's entire surface. The weight of this atmosphere exerts pressure, and its movements distribute heat from the Sun to balance global temperatures. Its gases filter out harmful radiation and disintegrate all but the largest meteoroids. Earth's atmosphere is a shell that protects and sustains the life forms that have evolved on its surface. Without the atmosphere's protection, life as presently known would not be possible.

When Earth astronauts leave the surface of their planet and travel into space, they must carry some of their environment with them. It must be contained in a physical shell because their body masses are too small to hold it in place by gravitational attraction alone. The shell that is used is called a spacecraft—a rigid collection of metal,



Earth as seen by the crew of the Apollo 17 Moon mission.

glass, plastic, and composites. Though far simpler in function than Earth's environment, a spacecraft's environment serves well for short missions lasting a few days or weeks. On some flights, the shell is deliberately opened and the astronauts pass through an airlock to venture outside. When doing so, they must be protected by a still smaller and very specialized version of their spacecraft called the Extravehicular Mobility Unit (EMU). This smaller spacecraft is composed of a spacesuit with a life-support system. It differs from the first spacecraft, or mother ship, in its anthropomorphic (human) shape and its flexibility. Astronauts wearing EMUs



need to be able to move arms, hands, and legs to perform an array of tasks in space. They must be able to operate many types of scientific apparatus, collect samples, take pictures, assemble equipment and structures, pilot themselves about, and repair

and service defective or worn-out satellites and other space hardware. The tasks of astronauts outside their mother ship are called extravehicular activities, or EVAs.



The Outer Space Environment



Outer space is just what its name implies. It is the void that lies beyond the uppermost reaches of the atmosphere of Earth and between all other objects in the universe. Although it is a void, outer space may be thought of as an environment. Radiation and objects pass through it freely. An unprotected human or other living being placed in the outer space environment would perish in a few brief, agonizing moments.

The principal environmental characteristic of outer space is the vacuum, or nearly total absence of

gas molecules. The gravitational attraction of large bodies in space, such as planets and stars, pulls gas molecules close to their surfaces leaving the space between virtually empty. Some stray gas molecules are found between these bodies, but their density is so low that they can be thought of as practically nonexistent.

On Earth, the atmosphere exerts pressure in all directions. At sea level, that pressure is 101 kilopascals. In space, the pressure is nearly zero. With virtually no pressure from the outside, air inside an unprotected human's lungs would immediately rush



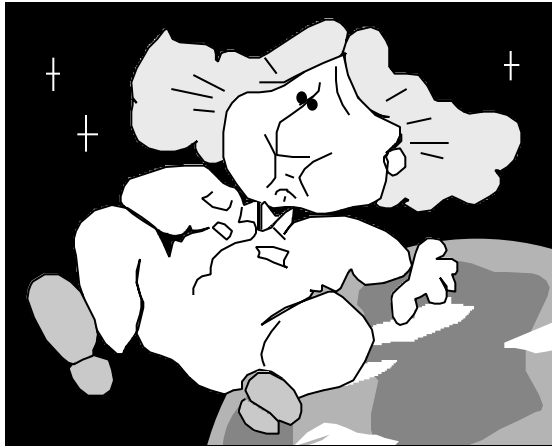

out in the vacuum of space. Dissolved gases in body fluids would expand, pushing solids and liquids apart. The skin would expand much like an inflating balloon. Bubbles would form in the bloodstream and render blood ineffective as a transporter of oxygen and nutrients to the body's cells. Furthermore, the sudden absence of external pressure balancing the internal pressure of body fluids and gases would rupture fragile tissues such as eardrums and capillaries. The net effect on the body would be swelling, tissue damage, and a deprivation of oxygen to the brain that would result in unconsciousness in less than 15 seconds.

The temperature range found in outer space provides a second major obstacle. The sunlit side of objects in space at Earth's distance from the Sun

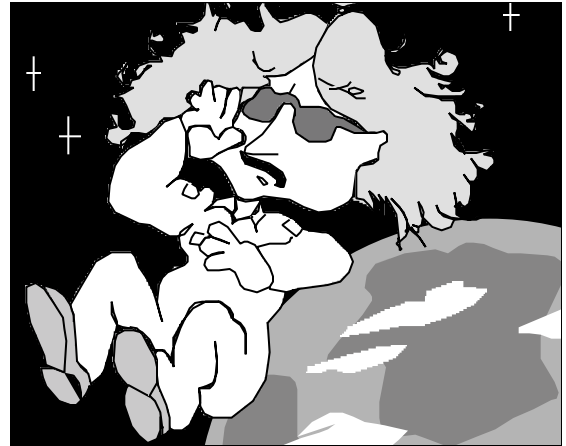

can climb to over 120° Celsius while the shaded side can plummet to lower than minus 100° Celsius. Maintaining a comfortable temperature range becomes a significant problem.

Other environmental factors encountered in outer space include: microgravity, radiation of electrically charged particles from the Sun, ultraviolet radi-

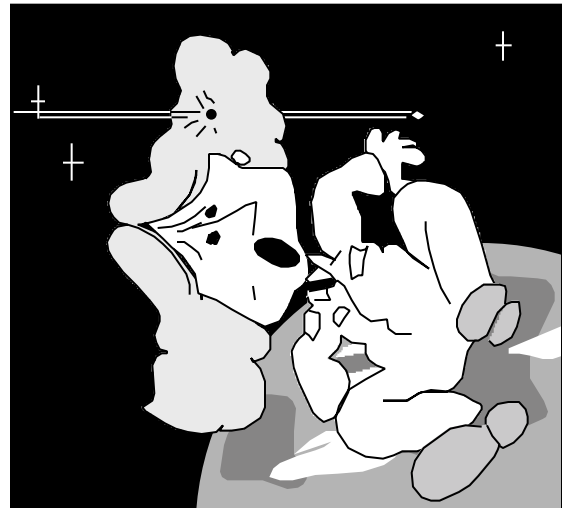

ation, and meteoroids. Meteoroids are very small bits of rock and metal left over from the formation of the solar system and from the collisions of comets and asteroids. Though usually small in mass, these particles travel at very high velocities and can easily penetrate human skin and thin metal. Equally dangerous is debris from previous space missions. A tiny paint chip traveling at thousands of kilometers per hour can do substantial damage.



Spacewalking History

The Extravehicular Mobility Unit worn during spacewalks by NASA's Space Shuttle astronauts represents more than 60 years of development and testing of pressure suits in the U.S., Russia, France, Italy, Germany, and other countries. It all began with high-altitude flyers, and one of the first was an American, Wiley Post. Post, an aviation pioneer of the 1930s, was seeking to break high-altitude and speed records. Post, as well as others, knew that protection against low pressure was essential. Through experience, aviators had learned that Earth's atmosphere thins with altitude.

At 5,500 meters, air is only one-half as dense as it is at sea level. At 12,200 meters, the pressure is so low and the amount of oxygen is so small that most living things perish. For Wiley Post to achieve the altitude records he sought, he needed protection. (Pressurized aircraft cabins had not yet been developed.) Post's solution was a suit that could be pressurized by his airplane engine's supercharger.

First attempts at building a pressure suit failed since the suit became rigid and immobile when pressurized. Post discovered he couldn't move inside the inflated suit, much less work airplane controls. A later version succeeded with the suit constructed already in a sitting position. This allowed Post to place his hands on the airplane controls and his feet on the rudder bars. Moving his arms and legs was



Aviation pioneer Wiley Post.

difficult, but not impossible. To provide visibility, a viewing port was part of the rigid helmet placed over Post's head. The port was small, but a larger one was unnecessary because Post had only one good eye!

During the next 30 years, pressure suits evolved in many ways and technical manufacturing help was gained from companies that made armor, diving suits, galoshes, and even girdles and corsets.



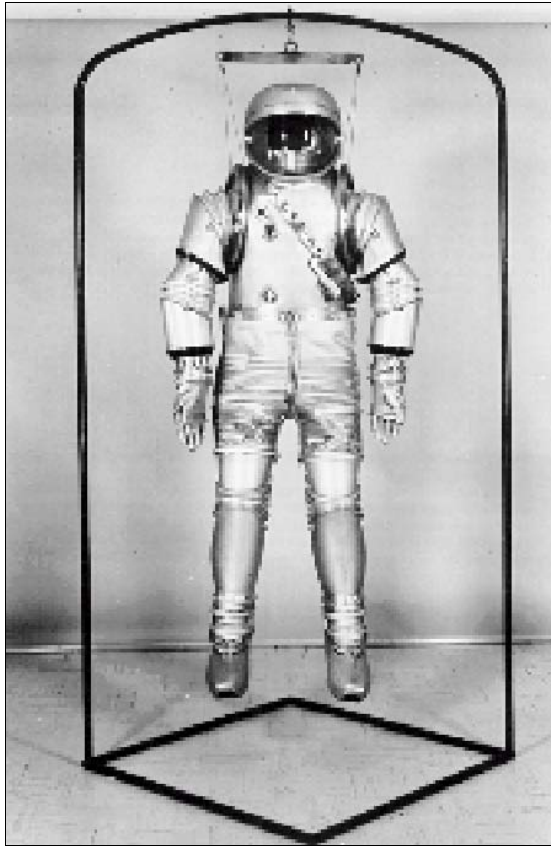

Early spacesuit design.

Designers learned in their search for the perfect suit that it was not necessary to provide full sea-level pressure. A suit pressure of 24.13 kilopascals (sea level–101 kilopascals) would suffice quite nicely if the wearer breathed pure oxygen. Supplying pure oxygen at this low pressure actually provides the breather with more oxygen than an unsuited person breathes at sea level. (Only one-fifth of the air at sea level is oxygen.)

Various techniques were used for constructing pressure garments. Some approaches employed a rigid layer with special joints of rings or cables or some other device to permit limb movements. Others used non-stretch fabrics—laced-up corset fashion.

With the advent of pressurized aircraft cabins, comfort and mobility in the suit when it was unpressurized became prime objectives in suit design. The suit could then be inflated in the event that the aircraft cabin lost pressure.

Project Mercury

By the time NASA began the Mercury manned space flight program, the best full-pressure suit design consisted of an inner gas-bladder layer of neoprene-coated fabric and an outer restraint layer of aluminized nylon. The first layer retained pure oxygen at 34.5 kilopascals; the second layer prevented the first from expanding like a balloon. This second fabric restraint layer directed the oxygen pressure inward on the astronaut. The limbs of the suit did not bend in a hinge fashion as do human arms and legs. Instead, the fabric arms and legs bent in a gentle curve, which restricted movement. When the astronaut moved one of his arms, the bending creased or folded the fabric inward near the joints, decreasing the volume of the suit and increasing its total pressure slightly. Fortunately for the comfort of the Mercury astronauts, the Mercury suit was designed to serve only as a pressure backup if the spacecraft cabin decompressed. No Mercury capsule ever lost pressure during a mission, and the suits remained uninflated.

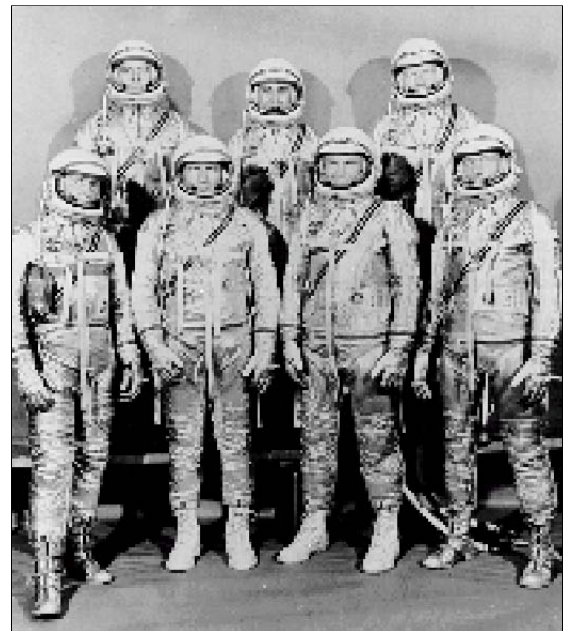

Project Mercury astronauts. (Front row, left to right) Walter M. Schirra, Jr., Donald K. Slayton, John H. Glenn, Jr., M. Scott Carpenter. (Back row, left to right) Alan B. Shepard, Jr., Virgil I. Grissom, L. Gordon Cooper, Jr.



Project Gemini

The six flights of the Mercury series were followed by ten flights in the Gemini program. Suit designers were faced with new problems. Not only would a Gemini suit have to serve as a pressure backup to the spacecraft cabin, but also as an escape suit if ejection seats had to be fired for an aborted launch and as an EMU for extravehicular activity. To increase mobility and comfort of the suit for long-term wear, designers departed from the Mercury suit concept. Instead of fabric joints, they chose a construction that employed a bladder restrained by a net. The bladder was an anthropomorphically shaped layer of neoprene-coated nylon. That was covered in turn with a layer of Teflon®-coated nylon netting. The netting, slightly smaller than the pressure bladder, limited inflation of the bladder and retained the pressure load in much the same way automobile tires retained the load in inner tubes in the days before tubeless tires. The new spacesuit featured improved mobility in the shoulders and arms and was more comfortable when worn unpressurized during space flights lasting as long as 14 days.

The first Gemini astronaut to leave his vehicle (“go EVA”) was Edward White, II. White exited from the Gemini 4 space capsule on June 3, 1965—just a few months after Leonov made the first Soviet spacewalk. For a half-hour, White tumbled and rolled in space, connected to the capsule only by an oxygen-feed hose that served secondary functions as a tether line and a communication link with the capsule. Although the term “spacewalk” was coined for the Gemini program, no actual walking was involved. On his spacewalk, White used a small hand-held propulsion gun for maneuvering in space. When he pulled a trigger, the gun released jets of nitrogen that propelled him in the opposite direction. It was the first personal maneuvering unit used in space.

Upon completion of the Gemini program, NASA astronauts had logged nearly 12 additional



Edward H. White's historic spacewalk.

hours of EVA experience. Approximately one-half of that time was spent merely standing up through the open hatch.

One of the most important lessons learned during the Gemini program was that EVAs were not as simple as they looked. Moving around in space required a great deal of work. The work could be lessened, however, by extensive training on Earth. The most effective training took place underwater. Wearing specially-weighted spacesuits while in a deep tank of water gave later Gemini crew members adequate practice in maneuvers they would soon perform in space. It was also learned that a better method of cooling the astronaut was required. The gas cooling system could not remove heat and moisture as rapidly as the astronaut produced them, and the inside of the helmet visor quickly fogged over making it difficult to see.

Project Apollo

Following Gemini, the Apollo program added a new dimension in spacesuit design because actual spacewalks (on the surface of the Moon) were now



to occur for the first time. As with Mercury and Gemini space garments, Apollo suits had to serve as a backup pressure system to the space capsule. Besides allowing flexibility in the shoulder and arm areas, they also had to permit movements of the legs and waist. Astronauts needed to be able to bend and stoop to pick up samples on the Moon. Suits had to function both in microgravity and in the one-sixth gravity of the Moon's surface. Furthermore, when walking on the Moon, Apollo astronauts needed the flexibility to roam freely without dragging a cumbersome combination oxygen line and tether. A self-contained portable life-support system was needed.

The Apollo spacesuit began with a garment that used water as a coolant. The garment, similar to long johns but laced with a network of thin-walled plastic tubing, circulated cooling water around the astronaut to prevent overheating. A multi-layered pressure garment was worn on top of the cooling suit. The innermost layer of this garment was a comfort layer of lightweight nylon with fabric ventilation ducts. On top of this was a layer of neoprene-coated nylon surrounded by a nylon restraint layer. This layer contained the pressure inside the suit. Improved mobility was achieved by bellow-like joints of formed rubber with built-in restraint cables at the waist, elbows, shoulders, wrist, knees, and ankles. On top of the pressure layer were five layers of aluminized Mylar® for heat protection, mixed with four spacing layers of non-woven Dacron®. Above these were two layers of Kapton and beta marquisette for additional thermal protection and a nonflammable and abrasion-protective layer of Teflon®-coated filament beta cloth. The outermost layer of the suit was white Teflon® cloth. The last two layers were flame resistant. In total, the suit layers provided pressure, served as a protection against heat and cold, and protected the wearer against micrometeoroid impacts and the wear and tear of walking on the Moon.

Capping off the suit was a communications headset and a clear polycarbonate-plastic pressure



Astronauts Harrison H. Schmitt (foreground) and Eugene A. Cernan practice sampling lunar sediment in a simulated Moon site constructed at the Kennedy Space Center in Florida. The Apollo 17 astronauts were the last humans to walk on the Moon.

helmet. Slipped over the top of the helmet was an assembly consisting of sun-filtering visors and adjustable blinders for sunlight protection. The final items of the Apollo spacesuit were lunar protective boots, a portable life-support system, and custom-sized gloves with molded silicone-rubber fingertips that provided some degree of fingertip sensitivity in handling equipment.

The life-support system, a backpack unit, provided oxygen for breathing and pressurization, water for cooling, and radio communications for lunar surface excursions lasting up to eight hours. Furthermore, back inside the lunar lander the life-support system could be recharged with more oxygen and battery power for additional Moonwalks.

During the Apollo program, 12 astronauts spent a total of 161 hours of EVA on the Moon's surface. Additional EVAs were spent in microgravity while the astronauts were in transit from the Moon to Earth. During a total of four hours, one





John W. Young, Commander of the Apollo 16 lunar landing mission to the Descartes region, salutes the American flag as he jumps upward in the one-sixth Earth gravity on the Moon. Behind him are the lunar module "Orion" and the lunar roving vehicle.

astronaut, the command module pilot, left the capsule to retrieve photographic film. There was no need for the portable life-support system away from the Moon, as those astronauts were connected to the spacecraft by umbilical tether lines supplying them with oxygen.

Skylab

NASA's next experience with EVAs came during the Skylab program and convincingly demonstrated the need for astronauts on a spacecraft. Spacesuited Skylab astronauts literally saved the Skylab program.

Skylab was NASA's first space station. It was launched in 1973, six months after the last Apollo Moon landing. Trouble developed during the launch when a micrometeoroid shield ripped away from the station's outer surface. This mishap trig-

gered the premature deployment of two of the six solar panels, resulting in one being ripped away by atmospheric friction. The second was jammed in a partially opened position by a piece of bent metal. In orbit, Skylab received insufficient electrical power from the remaining solar panels: the station was overheating because of the missing shield. Instead of scrapping the mission, NASA assigned the first three-astronaut crew the task of repairing the crippled station. While still on board the Apollo command module, Paul Weitz unsuccessfully attempted to free the jammed solar panel as he extended himself through the open side hatch. On board Skylab, the crew poked an umbrella-like portable heat shield through the scientific airlock to cover the area where the original shield was torn away. Later, on an EVA, the metal holding the jammed solar arrays was cut, and the panel was freed to open. During an EVA by the second Skylab



crew, an additional portable heat shield was erected over the first.

The Skylab EMU was a simplified version of the Apollo Moon suits. There was no need for the portable life-support system because the crew member was attached to the station by an umbilical tether that supplied oxygen and cooling water. An astronaut life-support assembly, consisting of a pressure-control unit and an attachment for the

tether, was worn on the chest, and an emergency oxygen package containing two supply bottles was attached to the right upper leg. A simplified visor assembly was worn over the pressure helmet. Lunar protective boots were not needed. Skylab astronauts logged 17.5 hours of planned EVA for film and experiment retrieval and 65 hours of unplanned EVA for station repairs.



The Space Shuttle Extravehicular Mobility Unit (EMU)

As NASA changed from launching astronauts on expendable rockets to the Space Shuttle system with its reusable orbiter and solid rocket boosters, spacesuit engineers began development of a reusable EMU. Previously, all spacesuits were one-time garments. Spacesuits were custom-built to each astronaut's body size. In the Apollo program, for example, each astronaut had three custom suits—one for flight, one for training, and one for flight backup. Shuttle suits, however, are tailored from a stock of standard-size parts to fit astronauts with a wide range of measurements.

In constructing the Shuttle spacesuit, developers were able to concentrate all their designs toward a single function—going EVA. Suits from earlier manned spaceflight programs had to serve multiple functions. They had to provide backup pressure in case of cabin pressure failure and, on Gemini missions, protection if ejection became necessary during launch. They also had to provide an environment for EVA in microgravity and in low gravity while walking on the Moon (Apollo missions). Suits were worn during lift off and reentry and had to be comfortable under the high-g forces experienced during acceleration and deceleration. Shuttle suits are worn only when it is time to venture outside the orbiter cabin. At other times, crew members wear comfortable shirts and slacks, or shorts. For launch

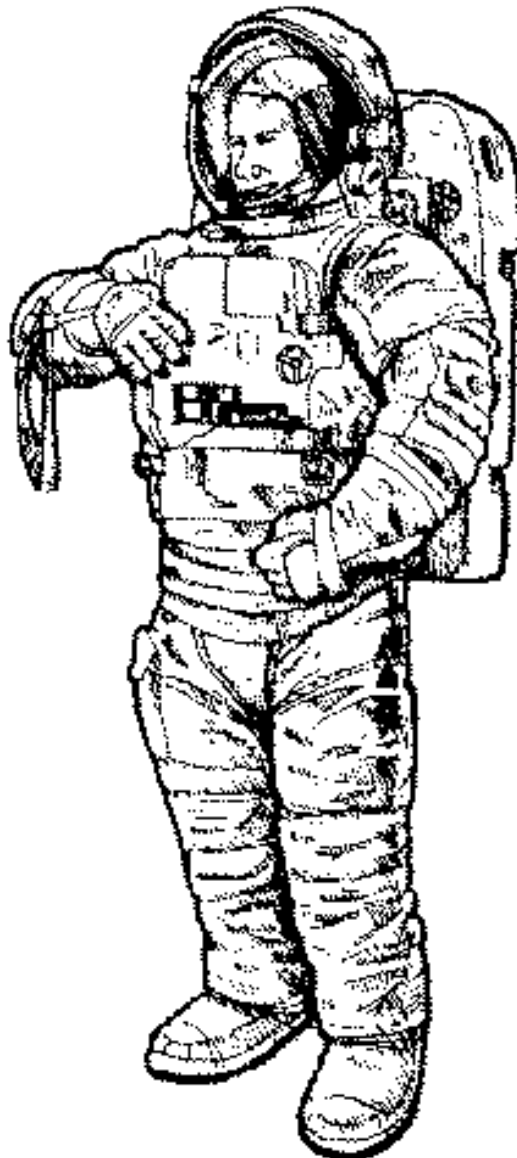

and reentry, special orange-colored flight suits with helmets are worn.

Many Layers

The Shuttle EMU has 14 layers to protect astronauts on EVAs. The inner layers comprise the liquid-cooling-and-ventilation garment. First comes a liner of Nylon tricot over which is a layer of spandex fabric laced with plastic tubing. Next comes the

pressure bladder layer of urethane-coated nylon and fabric layer of pressure-restraining Dacron®. Above the bladder and restraint layer is a liner of Neoprene coated Nylon Ripstop. This is followed by a seven-layer thermal micrometeoroid garment of aluminized Mylar®, laminated with Dacron® scrim. The outer layer of the suit is made of Ortho-Fabric which consists of a blend of Gortex®, Kevlar®, and Nomex® materials.

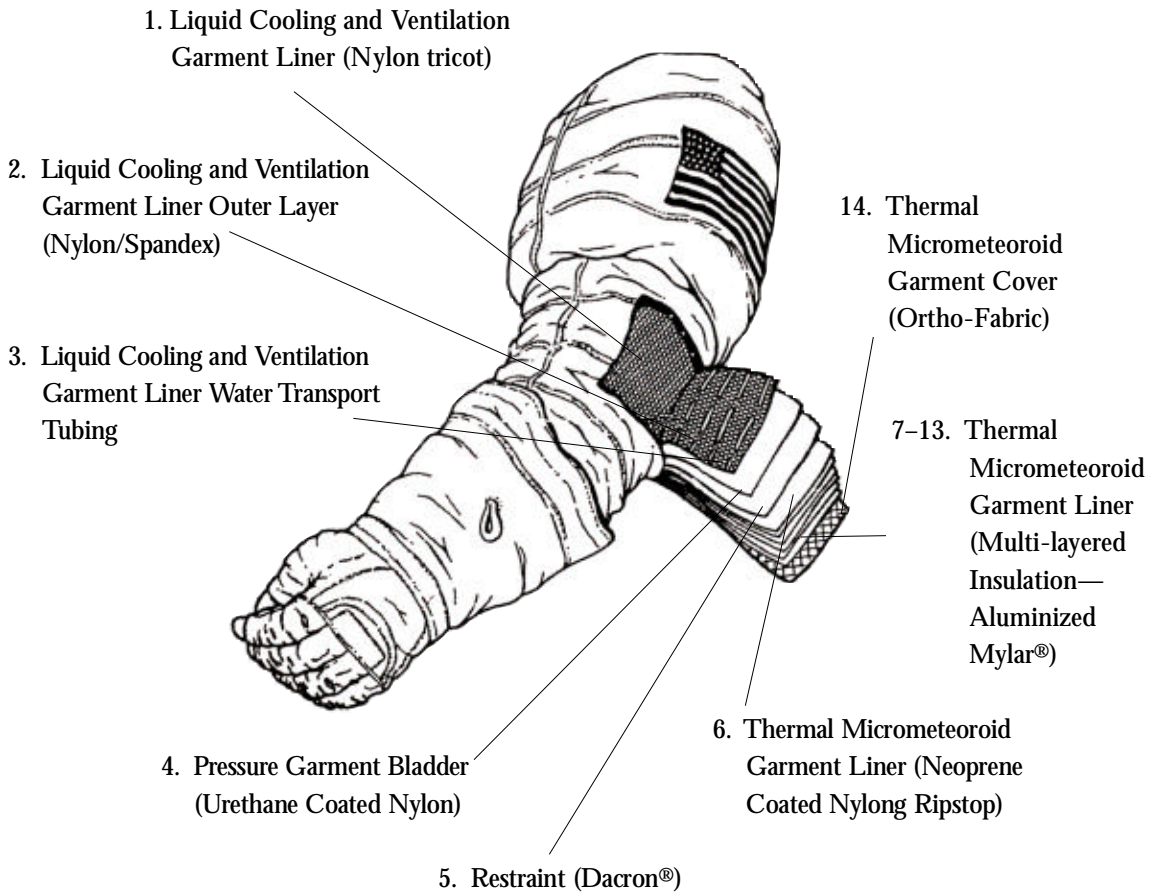

Shuttle EMU End Items

The Shuttle extravehicular mobility unit (EMU) consists of 18 separate items. Fully assembled, the Shuttle EMU becomes a nearly complete short-term spacecraft for one person. It provides pressure, thermal and micrometeoroid protection, oxygen, cooling water, drinking water, food, waste collection, (including carbon dioxide removal), electrical power, and communications. The EMU lacks only maneuvering capability, but this capability can be added by fitting a gas jet-propelled Simplified Aid for Extravehicular Activity Rescue (SAFER) over the EMU's primary life-support system. On Earth, the suit and all its parts, fully assembled but without SAFER, weighs about 113 kilograms. Orbiting above Earth it has no weight at all. It does, however, retain its mass in space, which is felt as resistance to a change in motion.

1. Primary Life-Support System (PLSS)

Self-contained backpack unit containing an oxygen supply, carbon-dioxide-removal equipment, caution and warning system, electrical power, water-cooling equipment, ventilating fan, machinery, and radio.



2. Displays and Control Module (DCM)

Chest-mounted control module containing all controls, a digital display, the external liquid, gas, and electrical interfaces. The DCM also has the primary purge valve for use with the Secondary Oxygen Pack.



3. EMU Electrical Harness (EEH)

A harness worn inside the suit to provide bioinstrumentation and communications connections to the PLSS.



4. Secondary Oxygen Pack (SOP)

Two oxygen tanks with a 30-minute emergency supply combined, valve, and regulators. The SOP is attached to the base of the PLSS. The SOP can be removed from the PLSS for ease of maintenance.

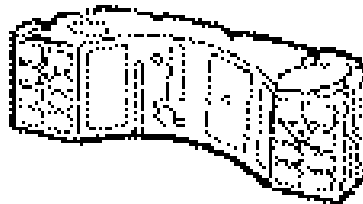

5. Service and Cooling Umbilical (SCU)

Connects the orbiter airlock support system to the EMU to support the astronaut before EVA and to provide in-orbit recharge capability for the PLSS.



The SCU contains lines for power, communications, oxygen and water recharge, and water drainage. The SCU conserves PLSS consumables during EVA preparation.



6. Battery

Battery that supplies electrical power for the EMU during EVA. The battery is rechargeable in orbit.



7. Contaminant Control Cartridge (CCC)

Cleanses suit atmosphere of contaminants with an integrated system of lithium hydroxide, activated charcoal, and a filter contained in one unit. The CCC is replaceable in orbit.

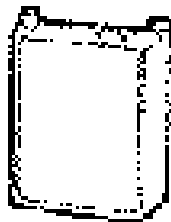

8. Hard Upper Torso (HUT)

Upper torso of the suit, composed of a hard fiberglass shell. It provides structural support for mounting the PLSS, DCM, arms, helmet, In-Suit Drink Bag, EEH, and the upper half of the waist closure. The HUT also has provisions for mounting a mini-workstation tool carrier.

9. Lower Torso

Spacesuit pants, boots, and the lower half of the closure at the waist. The lower torso also has a waist bearing for body rotation and mobility, and D rings for attaching a safety tether.

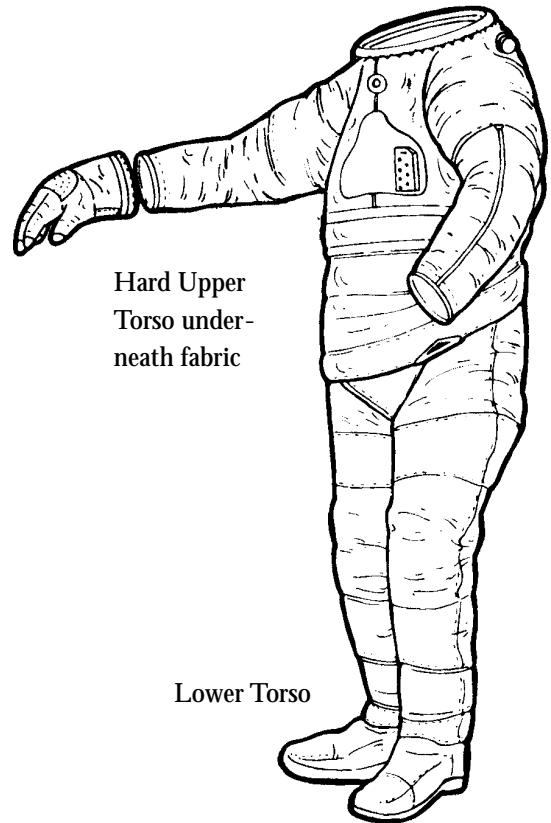

Hard Upper Torso underneath fabric

Lower Torso

Reference Numbers 8–11.

10. Arms (left and right)

Shoulder joint and shoulder bearing, upper arm bearings, elbow joint, and glove-attaching closure.

11. EVA Gloves (left and right)

Wrist bearing and disconnect, wrist joint, and fingers. The gloves have loops for attaching tethers for restraining small tools and equipment. Generally, crew members also wear thin fabric comfort gloves with knitted wristlets under the EVA gloves.



12. Helmet

Plastic pressure bubble with neck disconnect ring and ventilation distribution pad. The helmet has a backup purge valve for use with the secondary oxygen pack to remove expired carbon dioxide.



14. Maximum Absorption Garment (MAG)

An adult-sized diaper with extra absorption material added for urine collection.

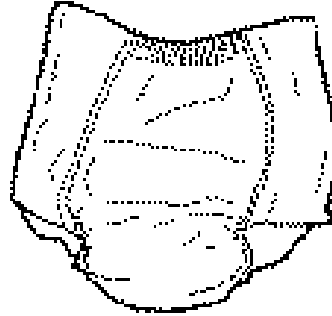

13. Liquid Cooling-and-Ventilation Garment (LCVG)

Long underwear-like garment worn inside the pressure layer. It has liquid cooling tubes, gas ventilation ducting, and multiple water and gas connectors for attachment to the PLSS via the HUT.

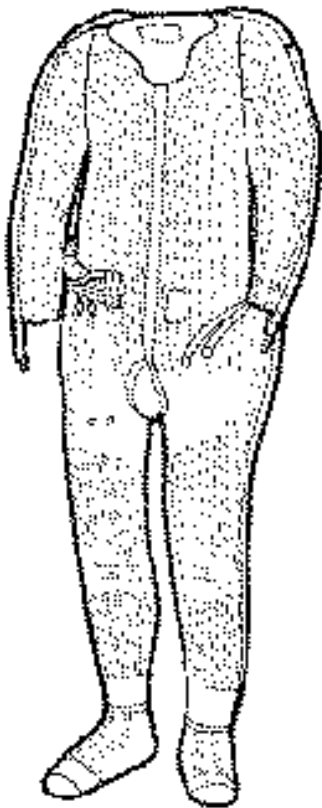

15. Extravehicular Visor Assembly (EVA)

Assembly containing a metallic-gold-covered Sun-filtering visor, a clear thermal impact-protective visor, and adjustable blinders that attach over the helmet. In addition, four small "head lamps" are mounted on the assembly; a TV camera-transmitter may also be added.



16. In-Suit Drink Bag (IDB)

Plastic water-filled pouch mounted inside the HUT. A tube projecting into the helmet works like a straw.



17. Communications Carrier Assembly (CCA)
Fabric cap with built-in earphones and a microphone for use with the EMU radio.



18. Airlock Adapter Plate (AAP)
Fixture for mounting and storing the EMU inside the airlock and for use as an aid in donning the suit.

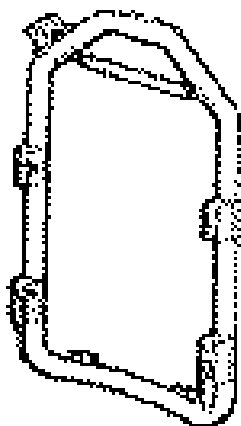

Putting on the EMU

Putting on a Shuttle EMU is a relatively simple operation that can be accomplished in a matter of about 15 minutes. However, the actual process of preparing to go EVA takes much longer. When working in the Shuttle cabin, crew members breathe a normal atmospheric mix of nitrogen and oxygen at 101 kilopascals. The suit's atmosphere is pure oxygen at 29.6 kilopascals. A rapid drop from the cabin pressure to the EMU pressure could result in a debilitating ailment that underwater divers sometimes experience—the bends. The bends, also

known as caisson disease, are produced by the formation and expansion of nitrogen gas bubbles in the bloodstream when a person breathing a normal air mixture at sea-level pressure is exposed to a rapid drop in external pressure. In severe cases, the bends are characterized by pains in the joints, cramps, paralysis, and eventual death if not treated by gradual recompression. To prevent an occurrence of the bends, crew members intending to go EVA spend a period of time prebreathing pure oxygen. During that time, nitrogen gas in the bloodstream is replaced by pure oxygen.

Prior to prebreathing, the atmospheric pressure of the entire orbiter cabin is depressed from the normal 101 kilopascals to 70.3 pascals while the percentage of oxygen is slightly increased. Prebreathing begins when the crew members who plan to go EVA don a mask connected to an oxygen supply. A short hose permits them to continue their EVA preparations during this period. The length of time for cabin decompression and the time for prebreathing is related. Without any cabin decompression, prebreathing must last at least four hours. A prebreathe of 30 minutes is safe providing cabin decompression takes place at least 24 hours before the exit into space.

By now, much of the dissolved nitrogen gas has been cleared from the EVA crew members, and they can remove their helmets. Later, when they don their spacesuits and seal the helmets, an additional 30 to 40 minutes of pure oxygen prebreathing takes place before the suits are lowered to their operating pressure of 29.6 kilopascals.

Most of the EMU-donning process takes place inside the airlock. The airlock is a cylindrical chamber located on the orbiter's mid-deck. One hatch leads from the middeck into the airlock, and a second hatch leads from the airlock out to the unpressurized payload bay.

Before entering the hatch, but following their initial prebreathing, the crew members put on the maximum absorbency garment (MAG). The MAG is an adult-size diaper.



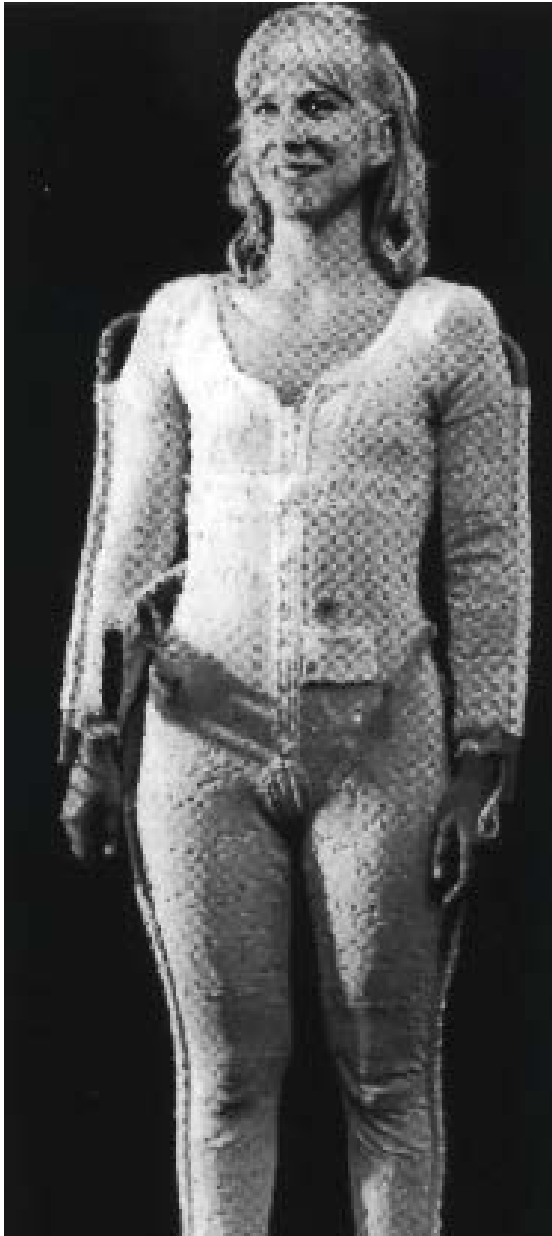

Spacesuit technician prepares to put on the Space Shuttle EMU by first donning the Liquid Cooling-and-Ventilation garment.

Next comes the Liquid Cooling-and-Ventilation Garment (LCVG). The LCVG has the general appearance of long underwear. It is a one-piece suit with a zippered front, made of stretchable spandex fabric laced with 91.5 meters of plastic tubing. When the EMU is completely assembled, cooling and ventilation become significant problems. Body heat, contaminant gases, and perspiration—all waste

products—are contained by the insulation and pressure layers of the suit and must be removed. Cooling of the crew member is accomplished by circulating chilled water through the tubes. Chilling the water is one of the functions of the Primary Life-Support System (PLSS). The PLSS device for water cooling and the tubing system are designed to provide cooling for physical activity that generates up to two million joules of body heat per hour, a rate that is considered “extremely vigorous.” (Approximately 160 joules are released by burning a piece of newsprint one centimeter square.) Ducting attached to the LCVG ventilates the suit by drawing ventilating oxygen and expired carbon dioxide from the suit’s atmosphere into the PLSS for purification and recirculation. Body perspiration is also drawn away from the suit by the venting system and recycled in the water cooling system. The intakes are located near the hands and feet of the suit. Ducts, running along the arms and legs on the back of the LCVG channel, the ventilation gases to a circular junction on the back of the LCVG and into the torso vent duct. From there, the gases are returned to the PLSS via the LCCGV multiple water connector. Purified oxygen from the PLSS reenters the suit through another duct, mounted in the back of the helmet, that directs the flow over the astronaut’s face to complete the circuit.

The EMU electrical harness is attached to the HUT and provides biomedical and communications hookups with the PLSS. The biomedical hookup monitors the heart rate of the crew members, and this information is radioed via a link with the orbiter to Mission Control on Earth. Voice communications are also carried on this circuit.

Next, several simple tasks are performed. Antifog compound is rubbed on the inside of the helmet. A wrist mirror and a small spiral-bound 27-page checklist are put on the left arm of the upper torso. The wrist mirror was added to the suit because some of the knobs on the front of the displays and control module are out of the vision range of the crew member. The mirror permits the knob



settings to be read. Setting numbers are written backwards for ease of reading in the mirror.

Another task at this time is to insert a food bar and a water-filled In-Suit Drink Bag (IDB) inside the front of the HUT. The food bar of compressed fruit, grain, and nuts is wrapped in edible rice paper, and its upper end extends into the helmet area near the crew member's mouth. When hungry, the crew member bites the bar and pulls it upward before breaking off a piece to chew. In that manner, a small piece of the bar remains extended into the helmet for the next bite. It is necessary to eat the entire bar at one time, because saliva quickly softens the protruding food bar, making it mushy and impossible to break off. The IDB is placed just above the bar. Two sizes of bags are available and the one chosen is filled with water from the water supply of the orbiter's galley prior to entry into the airlock. The largest bag contains nearly 1 liter of water. A plastic tube and valve assembly extends up into the helmet so that the crew member can take a drink whenever needed. Both the food bar and drink bag are held in place by Velcro attachments.

During EVAs, the crew members may need additional lighting to perform their tasks. A light-bar attachment (helmet-mounted light array) is placed above the helmet visor assembly. Small built-in flood lamps provide illumination to places that sunlight and the regular payload bay lights do not reach. The EVA light has its own battery system and can be augmented with a helmet-mountable television camera system with its own batteries and radio frequency transmitter. The camera's lens system is about the size of a postage stamp. Through this system, the crew remaining inside the orbiter and the mission controllers on Earth can get an astronaut's eye view of the EVA action. During complicated EVAs, viewers may be able to provide helpful advice for the tasks at hand.

Next, the Communications Carrier Assembly (CCA), or "Snoopy cap," is connected to the EMU electrical harness and left floating above the HUT. The CCA earphones and microphones are held by

a fabric cap. After the crew member dons the EMU, the cap is placed on the head and adjusted.

When the tasks preparatory to donning the suit are completed, the lower torso, or suit pants, are pulled on. The lower torso comes in various sizes to meet the varying size requirements of different astronauts. It features pants with boots and joints in the hip, knee, and ankle, and a metal body-seal closure for connecting to the mating half of the ring mounted on the hard upper torso. The lower torso's waist element also contains a large bearing. This gives the crew member mobility at the waist, permitting twisting motions when the feet are held in workstation foot restraints.

Joints for the lower and upper torsos represent an important advance over those of previous spacesuits. Earlier joint designs consisted of hard rings, bellows-like bends in the pressure bladder, or cable- and pulley-assisted fabric joints. The Shuttle EMU joints maintain nearly constant volume during bending. As the joints are bent, reductions in volume along the inner arc of the bend are equalized by increased volume along the outer arc of the bend.

Long before the upper half of the EMU is donned, the airlock's Service and Cooling Umbilical (SCU) is plugged into the Displays and Control Module Panel on the front of the upper torso. Five connections within the umbilical provide the suit with cooling water, oxygen, and electrical power from the Shuttle itself. In this manner, the consumables stored in the Primary Life-Support System will be conserved during the lengthy prebreathing period. The SCU also is used for battery and consumable recharging between EVAs.

The airlock of the Shuttle orbiter is only 1.6 meters in diameter and 2.1 meters high on the inside. When two astronauts prepare to go EVA, the space inside the airlock becomes crowded. For storage purposes and as an aid in donning and doffing the EMU, each upper torso is mounted on airlock adapter plates. Adapter plates are brackets on the airlock wall for supporting the suits' upper torsos.



With the lower torso donned and the orbiter providing consumables to the suits, each crew member “dives” with a squirming motion into the upper torso. To dive into it, the astronaut maneuvers under the body-seal ring of the upper torso and assumes a diving position with arms extended upward. Stretching out, while at the same time aligning arms with the suit arms, the crew member slips into the upper torso. As two upper and lower body-seal closure rings are brought together, two connections are made. The first joins the cooling water-tubing and ventilation ducting of the LCVG to the Primary Life-Support System. The second connects the biomedical monitoring sensors to the EMU electrical harness that is connected to the PLSS. Both systems are turned on, and the crew member then locks the two body-seal closure rings together, usually with the assistance of another crew member who remains on board.

One of the most important features of the upper half of the suit is the HUT, or Hard Upper Torso. The HUT is a hard fiberglass shell under the fabric layers of the thermal-micrometeoroid garment. It is similar to the breast and back plates of a suit of armor. The HUT provides a rigid and controlled mounting surface for the Primary Life-Support System on the back and the Displays and Control Module on the front.

In the past, during the Apollo Moon missions, donning suits was a very lengthy process because the life-support system of those suits was a separate item. Because the Apollo suits were worn during launch and landing and also as cabin-pressure backups, a HUT could not be used. It would have been much too uncomfortable to wear during the high accelerations and decelerations of lift-off and reentry. The life-support system had to be attached to the suit inside the lunar module. All connections between PLSS and the Apollo suit were made at that time and, with two astronauts working in cramped quarters, preparing for EVA was a difficult process. The Shuttle suit HUT eliminates that lengthy procedure because the PLSS is already attached. It also elimi-

nates the exposed and vulnerable ventilation and life-support hoses of earlier EMU designs that could become snagged during EVA.

The last EMU gear to be donned includes eyeglasses if needed, the communications carrier assembly (CCA), comfort gloves, the helmet with lights and optional TV, and EVA gloves. The two gloves have fingertips of silicone rubber that permit some degree of sensitivity in handling tools and other objects. Metal rings in the gloves snap into rings in the sleeves of the upper torso. The rings in the gloves contain bearings to permit rotation for added mobility in the hand area. The connecting ring of the helmet is similar to the rings used for the body-seal closure. Mobility is not needed in this ring because the inside of the helmet is large enough for the crew member’s head to move around. To open or lock any of the connecting rings, one or two sliding, rectangular-shaped knobs are moved to the right or the left. When opened, the two halves of the connecting rings come apart easily. To close and lock, one of the rings slides part way into the other against an O-ring seal. The knob is moved to the right, and small pins inside the outer ring protrude into a groove around the inside ring, thereby holding the two together.

All suit openings have locking provisions that require a minimum of three independent motions to open. This feature prevents any accidental opening of suit connections.

With the donning of the helmet and gloves, the spacesuits are now sealed off from the atmosphere of the air lock. The crew members are being supported by the oxygen, electricity, and cooling water provided by the orbiter. A manual check of suit seals is made by pressurizing each suit to 29.6 kilopascals d. (The “d” stands for differential, meaning greater than the air lock pressure.) Inside the air lock, the pressure is either 70.3 or 101 kilopascals. The suit’s pressure is elevated an additional 29.6 kilopascals, giving it a pressure differential above the air lock pressure. Once pressure reaches the desired level, the oxygen supply is shut off and the



digital display on the chest-mounted control module is read. To assist in reading the display, an optional Fresnel lens inside the space helmet may be used to magnify the numbers. Some leakage of spacesuit pressure is normal. The maximum allowable rate of leakage of the Shuttle EMU is 1.38 kilopascals per minute, and this is checked before the suit is brought back down to air lock pressure.

As the suit pressure is elevated, crew members may experience discomfort in their ears and sinus cavities. They compensate for the pressure change by swallowing, yawning, or pressing their noses on an optional sponge mounted to the left on the inside of the helmet ring. Attempting to blow air through the nose when pressing the nose on the sponge forces air inside the ears and sinus cavities to equalize the pressure.

During the next several minutes the two spacesuits are purged of any oxygen/nitrogen atmosphere remaining from the cabin; this is replaced with pure oxygen. Additional suit checks are made while the final oxygen prebreathe takes place.

The inner door of the air lock is sealed, and the air lock pressure bleed-down begins. A small depressurization valve in the air lock latch is opened to outside space, permitting the air lock atmosphere to escape. While this is taking place the EMU automatically drops its own pressure to 66.9 kilopascals and leak checks are conducted. Failure of the leak test would require repressurizing the air lock, permitting the EVA crew to reexamine the seals of their suits.

Final depressurization is begun by opening the air lock depressurization valve. The outer air lock hatch is then opened and the suited astronauts prepare to pull themselves out into the payload bay. As a safety measure, they tether themselves to the orbiter to prevent floating away as they move from place to place by hand holds. It is at this point that they disconnect the orbiter Service and Cooling Umbilical from the EMU. The PLSS begins using its own supply of oxygen, cooling water, and electricity. The astronauts pull themselves through the outer air lock hatch, and the EVA begins.

The Primary and Secondary Life-Support Systems

Astronauts experienced their first real freedom while wearing spacesuits during the Apollo Moonwalk EVAs, because of a portable life-support system worn on their backs. All other EVAs up to that time were tied to the spacecraft by the umbilical-tether line that supplied oxygen and kept crew members from drifting away. In one sense, the tether was a leash, because it limited movements away from the spacecraft to the length of the tether. On the Moon, however, astronauts were not hampered by a tether and, in the later missions, were permitted to drive their lunar rovers up to 10 kilometers away from the lander. (That distance limit was imposed as a safety measure. It was determined that 10 kilometers was the maximum distance an astronaut could walk back to the lander if a lunar rover ever broke down.)

Space Shuttle astronauts have even greater freedom than the Apollo lunar astronauts because their EVAs take place in the microgravity environment of space. They do employ tethers when EVAs center in and about the Shuttle's payload bay, but those tethers act only as safety lines and do not provide life support. Furthermore, the tethers can be moved from one location to another on the orbiter along a slide wire, permitting even greater distances to be covered.

The freedom of movement afforded to Shuttle astronauts on EVAs is due to the Primary Life-Support System (PLSS) carried on their backs. The PLSS, an advanced version of the Apollo system, provides life support, voice communications, and biomedical telemetry for EVAs lasting as long as seven hours. Within its dimensions of 80 by 58.4 by 17.5 centimeters, the PLSS contains five major groups of components for life support. Those are the oxygen-ventilating, condensate, feedwater, liquid transport, and primary oxygen circuits.



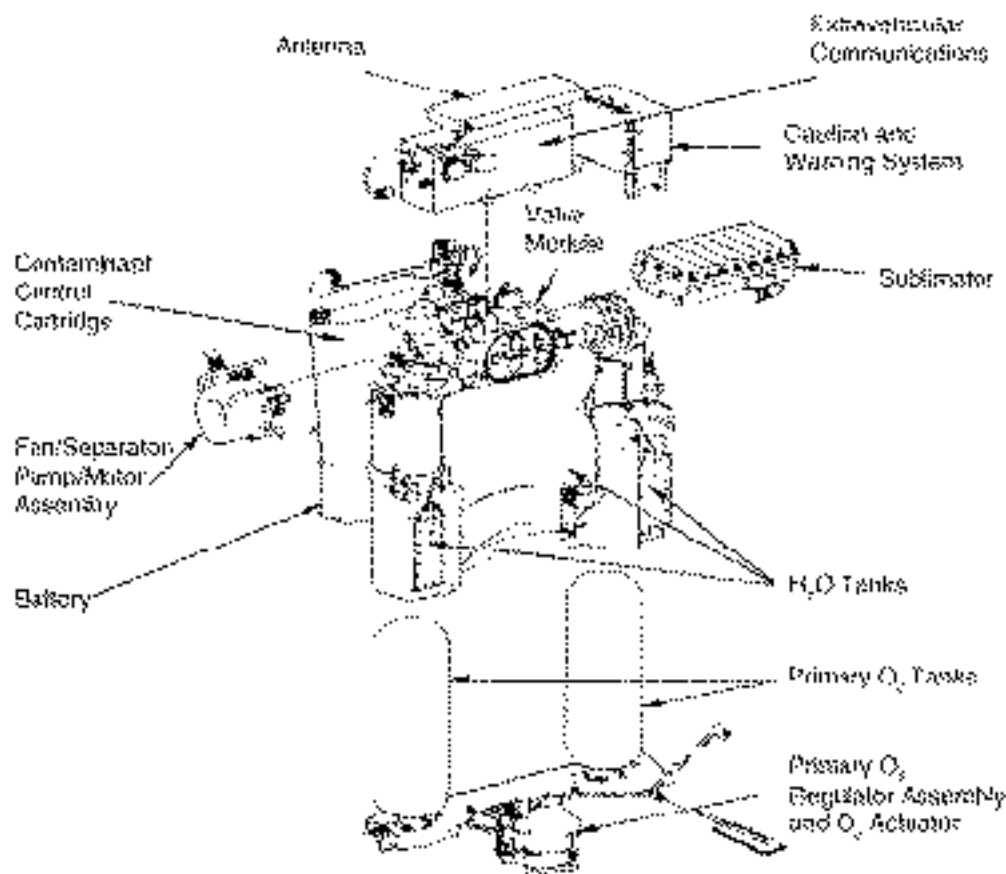

Primary Life-Support System

The oxygen-ventilating circuit is a closed-loop system. Oxygen is supplied to the system from the primary oxygen circuit or from a secondary oxygen pack that is added to the bottom of the PLSS for emergency use. The circulating oxygen enters the suit through a manifold built into the Hard Upper Torso. Ducting carries the oxygen to the back of the space helmet, where it is directed over the head and then downward along the inside of the helmet front. Before passing into the helmet, the oxygen warms sufficiently to prevent fogging of the visor. As the oxygen leaves the helmet and travels into the rest of the suit, it picks up carbon dioxide and humidity from the crew member's respiration. More humidity from perspiration, some heat from physical activity, and trace contaminants are also

picked up by the oxygen as it is drawn into the ducting built into the Liquid Cooling-and-Ventilation Garment. A centrifugal fan, running at nearly 20,000 rpm, draws the contaminated oxygen back into the PLSS at a rate of about 0.17 cubic meters per minute, where it passes through the Contaminant Control Cartridge.

Carbon dioxide and trace contaminants are filtered out by the lithium hydroxide and activated charcoal layers of the cartridge. The gas stream then travels through a heat exchanger and sublimator for removal of the humidity. The heat exchanger and sublimator also chill water that runs through the tubing in the Liquid Cooling and Ventilation Garment (LCGV). The humidity in the gas stream condenses out in the heat exchanger and sublima-





Astronaut Joe Tanner works on the Hubble Space Telescope during the STS-82 mission. The curvature of Earth and the Sun are over his left shoulder.

tor. The relatively dry gas (now cooled to approximately 13 degrees Celsius) is directed through a carbon dioxide sensor before it is recirculated through the suit. Oxygen is added from a supply and regulation system in the PLSS as needed. In the event of the failure of the suit fan, a purge valve in the suit can be opened. It initiates an open loop purge mode in which oxygen is delivered from both the primary and secondary oxygen pack. In this mode, moisture and the carbon dioxide-rich gas are dumped outside the suit just before they reach the Contaminant Control Cartridge.

One of the by-products of the oxygen-ventilating circuit is moisture. The water produced by perspiration and breathing is withdrawn from the oxygen supply by being condensed in the sublimator and is carried by the condensate circuit. (The small amount of oxygen that is also carried by the condensate circuit is removed by a gas separator and returned to the oxygen-ventilating system.) The water is then sent to the

water-storage tanks of the feedwater circuit and added to their supply for eventual use in the sublimator. In this manner, the PLSS is able to maintain suit cooling for a longer period than would be possible with just the tank's original water supply.

The function of the feedwater and the liquid transport circuits is to cool the astronaut. Using the pressure of oxygen from the primary oxygen circuit, the feedwater circuit moves water from the storage tanks (three tanks holding a total of 4.57 kilograms of water) to the space between the inner surfaces of two steel plates in the heat exchanger and sublimator. The outer side of one of the plates is exposed directly to the vacuum of space. That plate is porous and, as water evaporates through the pores, the temperature of the plate drops below the freezing point of water. Water still remaining on the inside of the porous plate freezes, sealing off the pores. Flow in the feedwater circuit to the heat exchanger and sublimator then stops.



On the opposite side of the other steel plate is a second chamber through which water from the liquid transport circuit passes. The liquid transport circuit is a closed-loop system that is connected to the plastic tubing of the LCVG. Water in this circuit, driven by a pump, absorbs body heat. As the heated water passes to the heat exchanger and sublimator, heat is transferred through the aluminum wall to the chamber with the porous wall. The ice formed in the pores of that wall is sublimated by the heat directly into gas, permitting it to travel through the pores into space. In this manner, water in the transport circuit is cooled and returned to the LCVG. The cooling rate of the sublimator is determined by the workload of the astronaut. With a greater workload, more heat is released into the water loop, causing ice to be sublimated more rapidly and more heat to be eliminated by the system.

The last group of components in the Primary Life-Support System is the primary oxygen circuit. Its two tanks contain a total of 0.54 kilograms of oxygen at a pressure of 5,860.5 kilopascals, enough for a normal seven-hour EVA. The oxygen of this

circuit is used for suit pressurization and breathing. Two regulators in the circuit step the pressure down to usable levels of 103.4 kilopascals and 29.6 kilopascals. Oxygen coming from the 103.4-kilopascal regulator pressurizes the water tanks, and oxygen from the 29.6-kilopascal regulator goes to the ventilating circuit.

To insure the safety of astronauts on EVAs, a Secondary Oxygen Pack (SOP) is added to the bottom of the PLSS. The two small tanks in this system contain 1.2 kilograms of oxygen at a pressure of 41,368.5 kilopascals. The Secondary Oxygen Pack can be used in an open-loop mode by activating a purge valve or as a backup supply should the primary system fall to 23.79 kilopascals. The supply automatically comes on line whenever the oxygen pressure inside the suit drops to less than 23.79 kilopascals.

If the Displays and Control Module (DCM) purge valve (discussed below) is opened, used-oxygen contaminants and collected moisture dump directly out of the suit into space. Because oxygen is not conserved and recycled in this mode, the large quantity of oxygen contained in the SOP is consumed in only 30 minutes. This half-hour still gives the crew member enough time to return to the orbiter's airlock. If carbon dioxide control is required, the helmet purge valve may be opened instead of the DCM purge valve. That valve has a lower flow rate than the DCM valve.

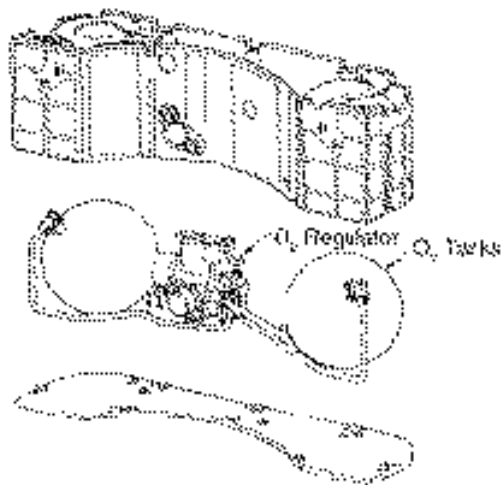

Secondary Oxygen Pack

Displays and Control Module

The PLSS is mounted directly on the back of the Hard Upper Torso, and the controls to run it are mounted on the front. A small, irregularly-shaped box, the Displays and Control Module (DCM), houses a variety of switches, valves, and displays. Along the DCM top are four switches for power, feedwater, communications mode selection, and caution and warning. A suit-pressure purge valve projects from the top at the left. It is used for depressurizing the suit at the end of an EVA and can be used in an emergency to remove heat and



humidity when oxygen is flowing from both the primary and secondary oxygen systems. Near the front on the top is an alpha-numeric display. A microprocessor inside the PLSS permits astronauts to monitor the condition of the various suit circuits by reading the data on the display.

Stepped down from the top of the DCM, on a small platform to the astronaut's right, is a ventilation-fan switch and a push-to-talk switch. The

astronaut has the option of having the radio channel open at all times or only when needed.

On a second platform, to the left, is an illuminated mechanical-suit pressure gauge. At the bottom, on the front of the DCM, are additional controls for communications volume, display lighting intensity, temperature control, and a four position selector for controlling suit pressure in different EVA operating modes.

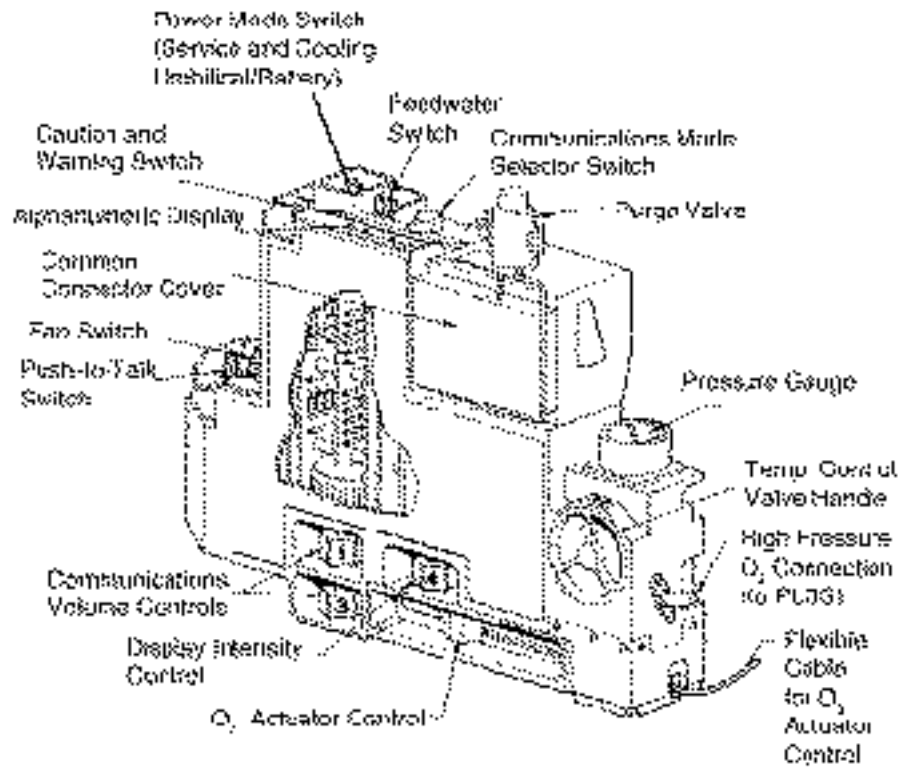

Display and Control Module



Working In Space

One of the great advantages of working in space is that objects, including the astronauts themselves, have no apparent weight. Regardless of the weight of an object on Earth, a single crew member can move and position that object in orbit with ease provided the crew member has a stable platform from which to work.

The physics of working in space is the same as that of working on Earth. All people and things contain matter and consequently have mass. Because of that mass, they resist any change in motion. Physicists refer to that resistance as inertia. The greater the mass, the greater the inertia.

Like on Earth, to change the motion of objects in space requires an application of force. How much the object moves is explained in part by Sir Isaac Newton's Third Law of Motion. The law states that a force causing an object to move one way is met with an equal and opposite force in the other direction. The law is more familiarly stated as, "For every action there is an opposite and equal reaction." The consequence of this law in space is important. A simple Earth task, such as turning a nut with a wrench, can become quite difficult in space because the astronaut—and not the nut—may turn.

Application of force on Earth is easy because we plant our feet firmly on the ground. We can

lift heavy objects upward because the equal and opposite force is directed downward through our legs and feet to Earth itself. Earth's inertia is so great that its response to the downward force is infinitesimal. In space, on the other hand, astronauts do not have the advantage of having a planet to stand on to absorb the equal and opposite force during work activities. As explained in the Third Law of Motion, pushing on an object causes the object and the crew member to float away in opposite directions. The rates at which the crew member and the object float away from each other is determined by their respective masses. For example, a massive satellite will move away much more slowly than the less massive astronaut pushing on it. To gain advantage over objects, the spacesuited crew member must be braced, through foot restraints, by a stable platform, such as a massive and actively stabilized Shuttle orbiter or International Space Station.

EVA

As Apollo spacesuits were being developed for walking on the surface of the Moon, a special set of tools was designed to assist astronauts in their sample collecting task. The Apollo suits were stiff, and bending at the waist was difficult and awkward.



The problem of picking up rocks and soil samples was solved by creating long-handled sampling tools such as scoops and rakes. Because bulky spacesuit gloves made grasping difficult, tool handles were made thicker than normal.

Today's spacewalkers have an extensive collection of EVA tools to employ during Shuttle and International Space Station missions. Several criteria are used in creating useful tools for space flight. Tools have to be easily gripped by astronauts wearing heavy gloves. The tools have to be safe to use and reliable under temperatures that can vary by hundreds of degrees. Tools also need some sort of attachment system so that if an astronaut should "drop" them, the tools will not float away. Colliding with a socket wrench left in orbit by some earlier space mission could be disastrous.

In the planning phase of each mission, tools are selected on the basis of the jobs that must be done. Specialized tools are often created when no existing tool will do the job. Many of the tools found in a traditional tool box on Earth are used in space as

well. The tools are modified to make them easier and safer to use in space. For example, the handles of tools are often enlarged so they will take less energy to hold. A spacesuit glove is similar to a thick leather welder's glove in bulk. Because the suit glove is pressurized, the astronaut's fingers extend out when at rest. Closing the fingers around a tool handle takes a continuous application of force. Quite simply, small-handled tools take more force to hold than do large-handled tools.

To keep control of tools, each tool has some sort of tether or locking system. A socket wrench has a key that has to be inserted into a holder before a socket can be installed at the end of the wrench. Once the key is removed, the socket is then locked onto the wrench and cannot be removed without use of the key again. A short tether and clip enables the astronaut to hang on to the wrench in case it is dropped. There is even a tether on the key. Rechargeable power tools for driving bolts are also used by spacewalkers.



STS-82 Astronaut Steven L. Smith holds a power ratchet tool as he prepares to replace some of the instruments on the Hubble Space Telescope.



EVA Tools

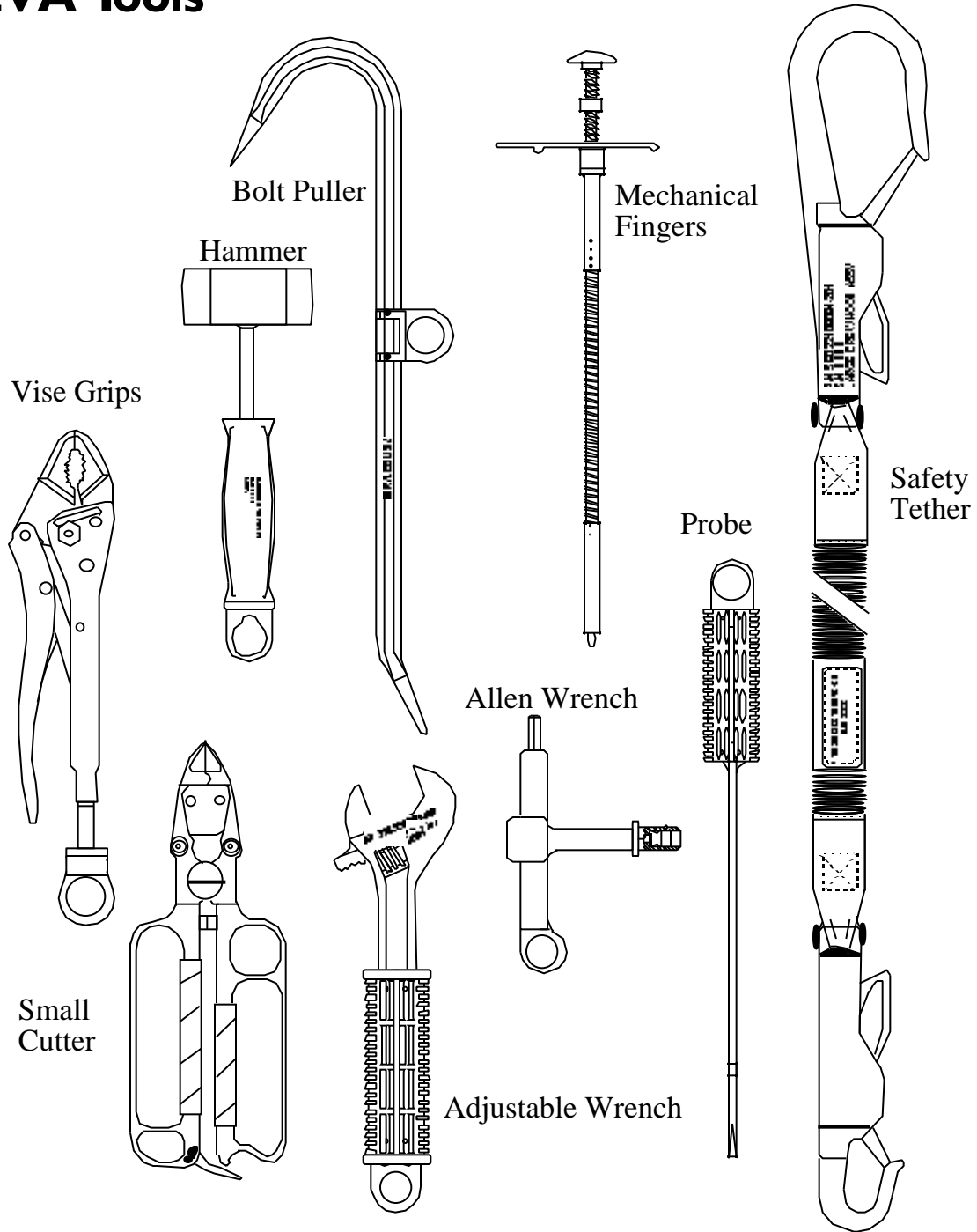

The tools shown here are representative samples of the tools available to spacewalkers. Many EVA tools are standard Earth tools that have been modified for space use. Loops, to attach tethers, are added to prevent loss in orbit. For some tools, such as the adjustable wrench and probe, the handle has been enlarged to make grasping with a spacesuit glove less tiring.





Bruce McCandless II pilots the MMU in space for its first flight.

Astronaut Maneuvering Units

During the first American EVA, Edward White experimented with a personal propulsion device, the Hand-Held Maneuvering Unit (HHMU). The HHMU tested by White was a three-jet maneuvering gun. Two jets were located at the ends of rods and aimed back so that firing them pulled White forward. A third jet was aimed forward to provide a braking force. By holding the gun near his center of mass and aiming it in the direction in which he wanted to travel, he was able to propel himself forward. Stopping that movement required firing the center jet. The propulsive force of the HHMU was produced by releasing compressed oxygen from two small built-in tanks.

Although the HHMU worked as intended, it had two disadvantages. To produce the desired motion, it had to be held as close to the astronaut's center of mass as possible. Determining the center position was difficult because of the bulky spacesuit White wore and was a matter of guesswork and experience. Furthermore, precise motions to position an astronaut properly during an activity such as servicing a satellite were difficult to achieve and maintain and proved physically exhausting.

On the Gemini 9 mission, a backpack maneuvering unit was carried. However, problems with the unit prevented Gene Cernan from testing it.

Following the Gemini program, the next space experiments that tested maneuvering units for EVAs took place during the second and third manned Skylab missions. The device was tested only inside the spacecraft, but the experiment confirmed that a maneuvering device of that design was both feasible and desirable for future EVA use. Five of the six astronauts who flew in those two missions accumulated a total of 14 hours testing the advanced device, called the AMU, or Astronaut Maneuvering Unit. The AMU was shaped like a large version of a hiker's backpack. Built into the frame was a replaceable tank of compressed nitrogen gas. Controls for the unit were placed at the ends of "arm rests." To move, the astronaut worked rotational and translational hand controls. Propulsive jets of nitrogen gas were released from various nozzles spaced around the unit. The 14 nozzles were arranged to aim top-bottom, front-back, and right-left to produce six degrees of freedom in movement. The AMU could move forward and back, up and down, and side to side, and could roll, pitch, and yaw. With the 11 additional nozzles, precise positioning with the AMU was far simpler than with the HHMU of the Gemini program. The astronaut was surrounded by the unit, taking the guesswork out of determining center of mass and making control much more accurate. The astronaut could move closely along the surface of a curved or irregularly-shaped object without making contact with it.

The AMU led to the MMU or manned maneuvering unit for use during early Space Shuttle flights. It was designed to operate in the microgravity environment of outer space and under the temperature extremes found there. The MMU was operated by a single space-suited astronaut. The unit featured redundancy to protect against failure of individual systems. It was designed to fit over the life-support system backpack of the Shuttle EMU.



The MMU was approximately 127 centimeters high, 83 centimeters wide, and 69 centimeters deep. When carried into space by the Shuttle, it was stowed in a support station attached to the wall of the payload bay near the airlock hatch. Two MMUs were carried on a mission with the second unit mounted across from the first on the opposite payload bay wall. The MMU controller arms were folded for storage, but when an astronaut backed into the unit and snapped the life-support system into place, the arms were unfolded. Fully extended, the arms increased the depth of the MMU to 122 centimeters. To adapt to astronauts with different arm lengths, controller arms could be adjusted over a range of approximately 13 centimeters. The MMU was small enough to be maneuvered with ease around and within complex structures. With a full propellant load, its mass was 148 kilograms.

Gaseous nitrogen was used as the propellant for the MMU. Two aluminum tanks with Kevlar® filament overwrappings contained 5.9 kilograms of nitrogen each at a pressure of 20.68 kilopascals, enough propellant for a six-hour EVA, depending on the amount of maneuvering done. In normal

operation, each tank fed one system of thrusters. At the direction of the astronaut, through manual control or through an automatic attitude-hold system, propellant gas moved through feed lines to varying combinations of 24 nozzles arranged in clusters of three each on the eight corners of the MMU. The nozzles were aimed along three axes perpendicular to each other and permit six degrees of freedom of movement. To operate the propulsion system, the astronaut used his or her fingertips to manipulate hand controllers at the ends of the MMU's two arms. The right-hand controller produced rotational acceleration for roll, pitch, and yaw. The left controller produced acceleration without rotation for moving forward-back, up-down, and left-right. Coordination of the two controllers produced intricate movements in the unit. Once a desired orientation had been achieved, the astronaut could engage an automatic attitude-hold function that maintained the inertial attitude of the unit in flight. This freed both hands for work.

The MMU was used on three Shuttle missions in the mid 1980s. It was first tested by Bruce McCandless and Robert Stewart on the 1984 STS

SAFER Propulsion Module

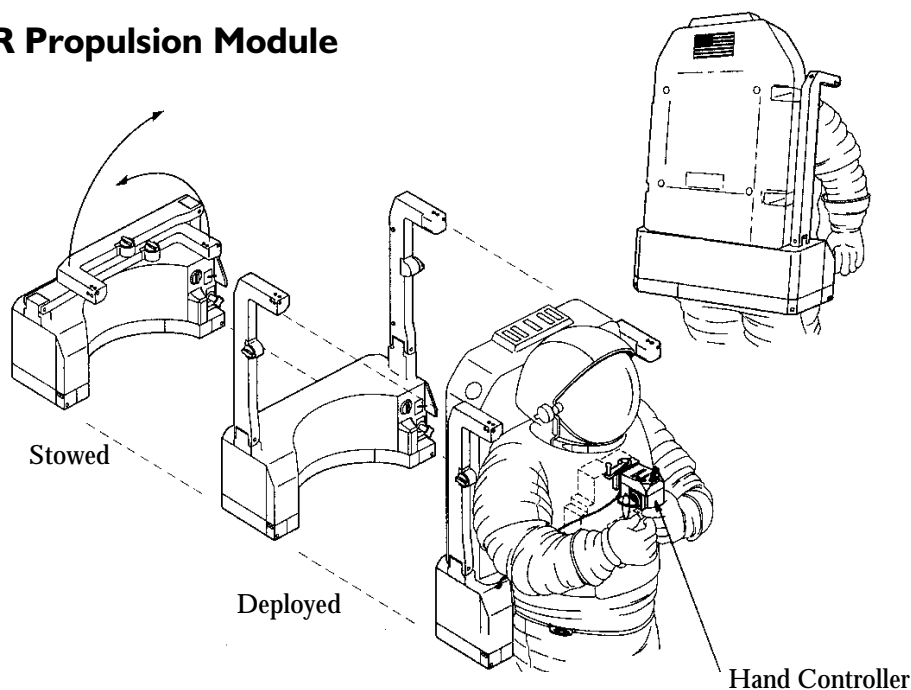



Mark C. Lee test flies the Simplified Aid for Extravehicular activity Rescue (SAFER) device during the STS-64 mission.

41-B mission. Taking turns, the two astronauts flew the MMU out from the orbiter's payload bay to a distance of about 100 meters and tested complex maneuvers. On STS-41C, the next Shuttle mission, James Van Hoften and George Nelson used the MMU to capture the Solar Maximum mission satellite and bring it into the orbiter's payload bay for repairs and servicing. Their work increased the life span of the satellite. The final MMU mission was STS-51A that flew in

November of 1984. The propulsion unit was used to retrieve two communication satellites that did not reach their proper orbit because of faulty propulsion modules. Joseph Allen and Dale Gardner captured the two satellites and brought them into the orbiter payload bay for stowage and return to Earth.

More recent experiments with astronaut maneuvering units took place on the 1994 STS-64 mission. A new device, called the Simplified Aid for Extravehicular activity Rescue (SAFER) was flown by Mark C. Lee and Carl J. Meade a few meters away from their orbiter. SAFER is a smaller unit than the MMU and is designed as a self-rescue device for use on the International Space Station. Although unlikely, an astronaut could become separated from the station during an EVA and a Shuttle not be available to retrieve the crew member. In that event, the crew member would use the propulsive power of SAFER to return to the station structure.

SAFER fits over the portable life support system of the Shuttle EMU. A control module consisting of a joystick and display is stowed in the bottom of SAFER. During operation, the control module is moved to the suit's front for easy access. With the controls the astronaut can expel nitrogen gas through 24 nozzles that are fixed in different orientations around the device. An autopilot system is available to keep the astronaut at the same orientation for a limited period of time. SAFER features the same maneuverability as the MMU but because its nitrogen tank only holds 1.4 kilograms of nitrogen gas, the total velocity change possible with the unit is 3.05 meters per second.



E VAs on the International Space Station

In recent years, NASA has increased the frequency of extravehicular activity to prepare for the assembly of the International Space Station beginning in the late 1990s. Two recent extraordinary Shuttle missions have demonstrated the potential for EVA on the Space Station. These were the STS-61 and STS-82 missions in 1993 and 1997 in which astronauts conducted multiple spacewalks to service the Hubble Space Telescope. During each flight, crew members donned their spacesuits and conducted EVAs in which they replaced instruments and installed new solar panels. Their servicing activities required extreme precision and dexterity during EVAs lasting more than seven hours.

Similar efforts will be needed for the assembly of the International Space Station. During the nearly 40 American and Russian space flights to the station, astronauts and cosmonauts will log over 1,200 hours of EVAs. More hours of spacewalks are expected to be conducted during just the years 1999 and 2000 than were conducted during all previous US space flights.

Spacewalkers will assist in the assembly of the Space Station by making all the connections that require greater dexterity than can be accomplished with station robots. These operations include joining electrical cables and fluid transfer lines and installing and deploying communication antennas. To do this,

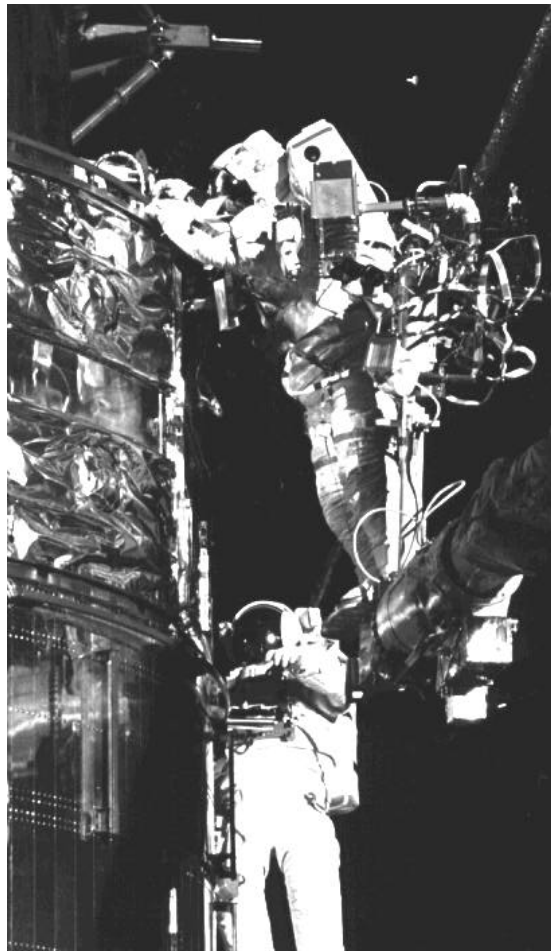

STS-82 (1997) astronauts Mark C. Lee (top) and Steven L. Smith (bottom) repair a worn area in the insulation of the Hubble Space Telescope. Detailed work like this will be a frequent occurrence during the assembly and operation of the International Space Station.



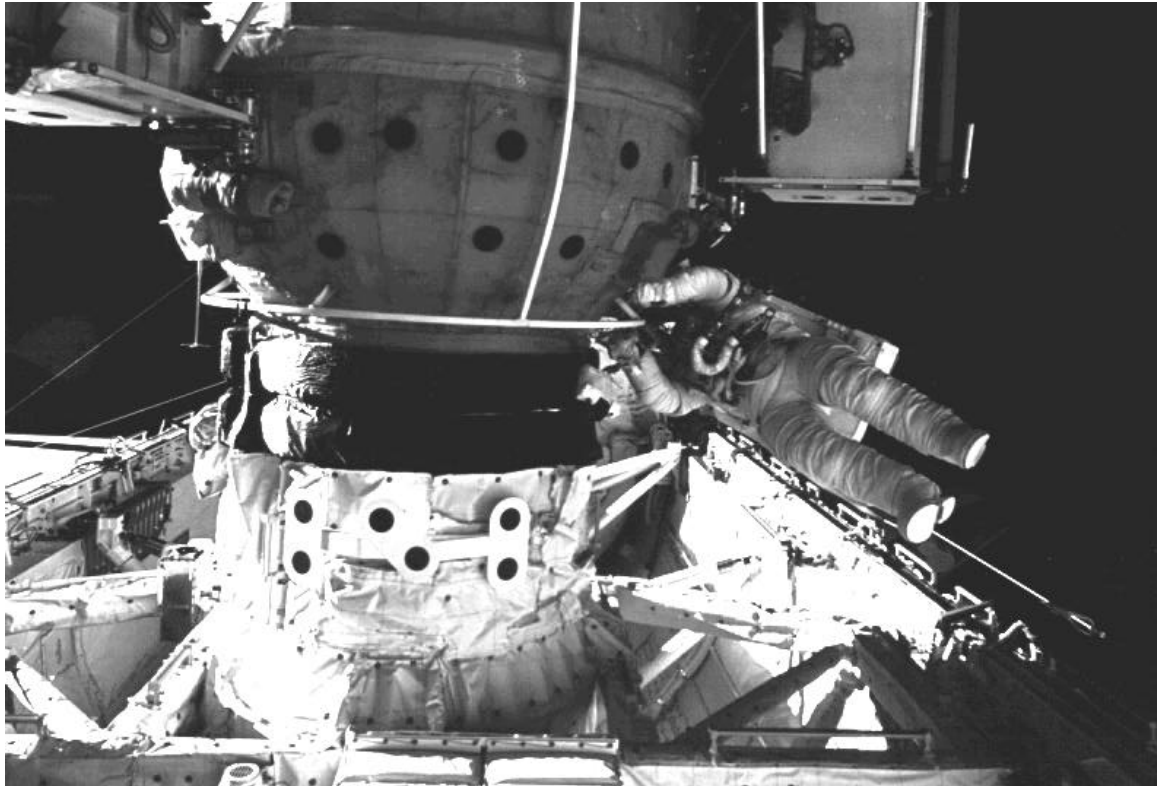

STS-76 astronaut Michael R. Clifford works with a restraint bar on the Docking Module of the Russian MIR space station. Similar docking modules (Pressurized Mating Adaptor) will be used on the International Space Station.

spacewalkers will have to remove locking bolts that secured components during launch to orbit.

As the Space Station evolves, astronauts will move components, such as antennas, to the most advantageous locations. For example, a communications antenna may become blocked when additional station modules are joined to the structure. Spacewalkers will have to traverse the outside of the modules and reposition the antenna where it will be unblocked by modules, solar panels, and other structures.

Still other Space Station EVA assembly tasks include removing of locking bolts for solar panels and radiators, driving bolts that hold the truss

assembly to the Space Station, attaching grapple fixtures to objects that have to be moved by the Space Station's robot arms, mounting tool kits, adding batteries, and reconfiguring valves for fluid transfer. Later, during the operational phase of the International Space Station, spacewalkers will replace orbital replacement units (ORUs). These are modular devices, such as the scientific instruments on the Hubble Space Telescope, that are designed to be removed periodically and replaced with improved or more advanced equipment. Operational spacewalks will also take care of mounting external payloads that are brought up to the Space Station on the Space Shuttle.



Future Space Suits

The current Extravehicular Mobility Unit (EMU) and all its associated EVA systems are the result of many years of research and development. They now comprise a powerful tool for orbital operations, but they are not end-of-the-line equipment. Many improvements are possible; the spacesuit of the future may look dramatically different from the Space Shuttle EMU.

Advanced versions of the EMU are being studied, including spacesuits that operate at higher pressures than the current EMU. The advantage of higher operating pressures is that virtually no time will be lost to prebreathing in preparation for EVA.

To build an operational high-pressure suit requires improved joint technology and integration of those joints into the suit. Under consideration are fabric and metal suits and suits with a hard external shell. Most of the technology needed for these suits has already been tested. One of the biggest challenges is to make a highly mobile glove. At higher operating pressures, fingers of older-style spacesuit gloves become so increasingly stiff that finger dexterity is severely reduced. Research to address this problem has led to the development of high-pressure gloves made with metal bands for knuckle and palm joints. These gloves show potential for use with future suits as well as with current suits, but there is still more work to be done. One line of

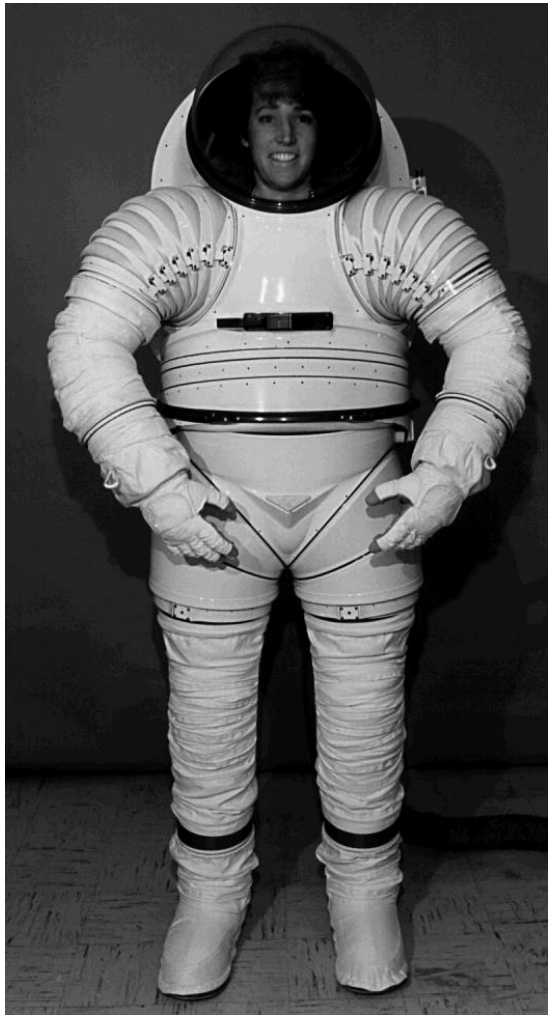

The Mark III Hard Suit is modeled by a spacesuit engineer.





A prototype of a next-generation spacesuit is tested.

research has explored incorporating robotic aids into the glove such as motor and cable systems to provide grasping force at higher pressures. So far, such systems have not been successful because of the extra bulk added to the hands and arms of the suit and because of the "what if" problem of a system failing while the hand is clamped onto an object. That could make it very difficult to release the object.

Another improvement in suit design will permit servicing and resizing suits in orbit. This improvement has already been tested on the STS-82 mission to service the Hubble Space Telescope. The original design of the Space Shuttle EMU required the removal or the addition of sizing inserts to lengthen or shorten legs and arms. This



Spacesuit technicians test the mobility of a proposed hybrid suit design.

was a lengthy process because it involved lacing pieces together. Quick disconnect sizing inserts have been designed that greatly speed up and simplify the process. The new system involves threaded quick disconnects, aluminum sizing rings, and adjustable restraint lines. The capability of servicing and resizing suits in space is vital for operations on the International Space Station. There, crew members will remain in space for months at a time, and EVAs will be routine events. With this and other improvements in design, spacesuits will be able to be used 25 times on the International Space Station over a period of 180 days before they have to be returned to Earth for major reservicing.

Another suit improvement is an electronic version of the checklist worn on the arm. The new system, similar to a pocket electronic organizer, will enable the spacewalker to run through complex sequences at the touch of a button. The checklist can be easily reprogrammed for new tasks. It may also have the capability of displaying television pictures from external cameras.



Other Worlds

For the most part, the design of a spacesuit is based on the environment in which it operates. Space Shuttle spacesuits for use in Earth orbit are designed to operate in a vacuum and microgravity. A spacesuit for use on the surface of the Moon or Mars will require a different design. On the Moon,

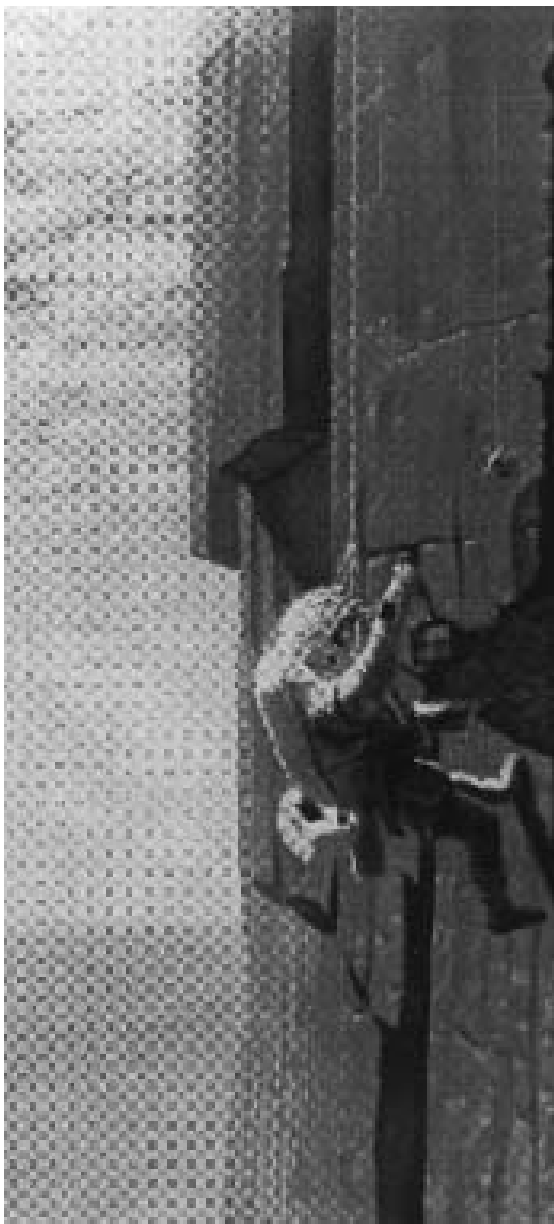

A future Martian explorer takes rock samples dangling off the escarpment of the Olympus Mons volcano. Pat Rawlings, SAIC.

a Space Shuttle style spacesuit would weigh about 19 kilograms. The suit will operate in an environment in which there is an up and a down direction. Circulatory pumps in the suit will face increased loads. Temperature extremes on the Moon will be about the same as in orbit about Earth when in direct sunlight and in shade. However, when the astronaut walks on the Moon, heat will be conducted into or out of the suit via the feet. On Mars, a Space Shuttle style spacesuit would weigh about 43 kilograms, exhausting the astronaut who has to wear it for long periods of exploration. Consequently, lighter EMU structures will be needed to lessen the load a future Martian explorer will carry. In addition, the thin Martian atmosphere may provide too much pressure for a cooling sublimator to work. Some other cooling strategy will have to be devised. Still another concern is to provide protection from dust that is carried by Martian winds and will be kicked up by the explorers. On the Moon, lunar sediment is very angular and abrasive but there is no atmosphere to stir it up. Until samples of the Martian sediment are returned to Earth, we won't know how abrasive it will be. These and other properties of the Moon and Martian environment provide interesting and exciting challenges to spacesuit designers and builders.

EVA

Starting with Edward White II's spacewalk in 1965, American astronauts have logged many hundreds of hours of extravehicular activity in space. Mission planners correctly foresaw the role EVA would play in future space missions. The early Gemini experience was primarily experimental. During the Apollo and Skylab programs, EVA was critical to success. With the Space Shuttle and the International Space Station, it is even more critical. By donning the EMU, an astronaut becomes a small, short-term spacecraft. Space-suited crew members can manipulate payloads, make adjustments, repair broken parts, join pieces together,





Future spacewalkers will roam the surface of the Moon and Mars. This picture, painted by artist Pat Rawlings of SAIC, shows the first humans to explore the surface of Mars. The explorers, wearing spacesuits specially-designed for the Martian environment, are scouring the surface looking for clues to the planet's history and evidence for signs of life.

and handle a host of other activities. Most important, they bring with them the human ability to cope with unexpected or unusual situations that

occur in the hard and unforgiving environment of outer space.



Activities—Designing Spacesuits for Mars

Technology Education, Science, and Mathematics



Introduction:

The steps spacesuit engineers and technicians followed in achieving a goal of creating reliable space-suit systems for exploration of the surface of the Moon and for construction and maintenance work in Earth orbit were the same as those used in nearly every technological endeavor:

Challenge

Design and construct a protective garment that will permit humans to venture safely into outer space and perform work.

Research

Investigate the environment in which the garment will be worn and determine what protective measures must be employed.

Management

Organize the effort into teams that design suit subsystems and investigate and select appropriate materials and technologies.

Fabricate Prototypes

Construct and assemble suit subsystems into the completed garment.

Evaluate

Test the garment in a simulated space environment and make modifications where needed.

Manufacture

Construct operational spacesuits.

Ongoing Evaluation

Continue refining spacesuit subsystems to improve efficiency, reliability, versatility, and safety while lowering costs.

The pages that follow outline a multifaceted technology education activity on spacesuits. This activity, designed for an entire class to work on as a

team, combines skills and content from science, mathematics, and technology. The challenge is to design and build a full-scale wearable model space-suit to be used to explore the surface of Mars. Since no human expeditions to Mars are planned for many years, actual Martian spacesuits have not yet been built and there are no "right" answers. Consequently, this activity permits students to participate in "leading edge" research.

The overview of the activity is contained in a Design Brief format. It begins with a title and a context statement (introduction) and is followed by a challenge to create a Martian spacesuit. This is followed by information on materials, equipment, procedures, and evaluation. The success of the activity depends upon how well the students organize their work and communicate with each other. A computer with project software can be used to monitor the progress of the project or a flow chart can be constructed on a chalk or bulletin board. As an added aid to communication, Interface Control Documents (ICD) are created as systems are designed. (Reproducible master on page 49. Sample

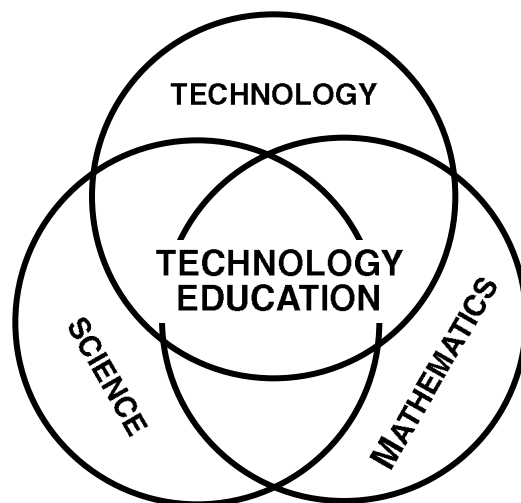

Technology Education is a multi-disciplinary subject combining mathematics, science, and technology.



document on page 50.) These documents are completed by the teams. Critical details about systems, such as size, shape, and function, are recorded on the form. The form has a grid where diagrams can be made. ICD forms are then placed in a notebook and made available to all teams as a coordination tool. An ICD master is provided.

If desired, the project can be divided among several classes (or even several schools) which will each have to work together. This is the way major NASA projects are divided between contractors and sub-contractors located across the country.

To support the activity, a collection of Teacher Tech Briefs (TTB) are included. These briefs provide suggestions for your use when guiding students in accomplishing their tasks. For example, if student teams conclude that high-speed particles (micrometeoroids) are a problem in the Martian environment, plans are provided for a device that measures impact damage to materials. TTBs are not intended as "blue

prints" for students to use. Rather, they provide information on one of many ways in which the task can be accomplished. Students will build an impact test stand of their own design. TTBs aid you in facilitating the students' ideas. Following the TTBs is a section on spacesuit testing apparatus used at the NASA Johnson Space Center. The apparatus are "one of a kind" devices created by following the same design process students will use.

Exploration Briefs (EBs) are suggestions for activities that can be used to help students understand the nature of the environment for which they are designing a spacesuit. They provide background information and instructions for simple demonstrations and experiments that may be tried. A "bank" of additional ideas follow the EBs.

The guide concludes with appendices that list resources, such as NASA publications and Internet web sites, where students can obtain more information to help them in their research and development work.





Design Brief

Context:

Spacesuits are one of the important enabling technologies that have permitted humans to explore outer space. To survive the hostile environment, humans had to be covered with a protective shell as they exited their spacecraft. This shell contained a part of Earth's surface environment while remaining flexible and impervious to the unique hazards, such as high-speed particle impacts, encountered there. These requirements meant that engineers and technicians had to spend long hours investigating and selecting appropriate materials, finding ways of fabricating and joining suit parts together, and providing operating pressure, power, and communications while assembling a garment that was tough but flexible. The task was achieved with such great success that astronauts and cosmonauts have safely conducted thousands of hours of extravehicular activity.

Challenge:

Design and build a protective garment that will permit future space travelers to explore the surface of Mars. The garment must protect the person inside from the hazards of the Martian environment while remaining comfortable to wear. Excursions on the surface will nominally last 8 hours, but the garment will have to function as long as 10 hours in emergency situations. The garment must be flexible enough to enable the wearer to walk up to 10 kilometers, collect geologic samples, and operate a variety of tools and experimental apparatus. Furthermore, the garment's design must be rugged enough to permit repeated use and be able to be serviced simply and quickly. Along with the garment, design a collection of geologic sampling tools, such as rock hammers, and a general set of tools for assembly and repair activities. These tools should be easy to use while wearing the protective garment, be safe and rugged, and interface with a general purpose tool carrier that must also be designed.

Procedures:

Select subcontractor teams to design and construct each of the garment's components, such as the helmet or gloves. Teams will coordinate their work with each other as materials for and sizes of the components are selected.

Materials:

Use whatever materials you find to construct the garment's components. Test these materials to ensure they will survive the Martian environment. Existing tools can be modified for use on Mars.

Evaluation:

Conduct periodic team evaluations of the progress of the garment and tool design process. When all components are completed, integrate them for a full test in a simulated Martian environment. Evaluate the garment and tools on the basis of the criteria presented in the context section.



Interface Control Document

Page 1 Of 1

System Name: Space Helmet

Team Members _____

Project No. 8

Peter _____

Date: Nov. 22, 1997 Rev. No. 4

Kiesha _____

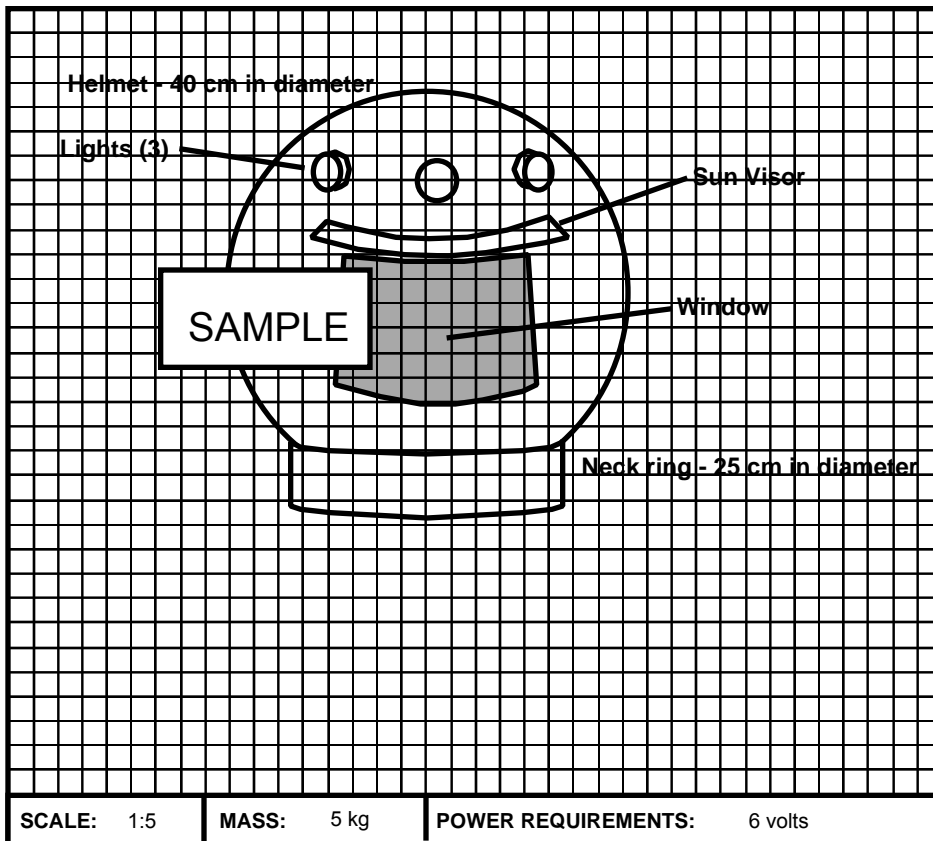

Briefly explain how this system functions.

_____ The helmet seals off the top of the suit. It has a window for looking
_____ out and a sun visor. The neck ring connects to the shoulders of the
_____ suit.

Interface Control Documents are a communication tool that helps the various Martian Surface Exploration Suit design teams to coordinate with each other. This sample shows a design for a space helmet. The team working on the upper torso will learn from this document how large the connection with the helmet has to be.



Teacher Tech Brief

Tensile Strength Test Strand

Context

The different materials used in constructing the Space Shuttle EMU were chosen because they each featured properties deemed desirable for spacewalking. Depending upon their intended purpose, material may have to withstand tears, punctures, temperature extremes, bending, abrasion, or any combination of the above.

Purpose

This test stand measures materials for their resistance to tensile (stretching) forces.

Principle

Using the mechanical advantage of a pulley setup, tensile forces are exerted on test samples until they break.

Materials and Tools Checklist

- Wooden base (6" x 1" x 4')
- Threaded iron pipe (1 pc 3/4" x 2')
(2 pcs 3/4" x 3')
- Pipe elbows (2 pcs)
- Pipe flanges (2 pcs)
- Screws for flanges
- Pulley (1 single)

- Pulley block (1 double, 1 triple)
- Cord for pulleys
- Clamps (2)
- Metric Ruler
- Pointer (stiff wire)
- Hose clamps (2 pcs)
- Lead weights (25 kg)
- Bucket
- Screwdriver
- Pipe wrench
- Materials to be tested
- Eye Protection

Operation

Obtain different fabric samples from remnant tables at fabric stores. Also ask students to bring in samples with which to work. Cut the material to be tested into a rectangular strip 1 centimeter by 10 centimeters in size. The sample is held between two clamps as shown in figure 1. Place a small number of lead weights in the bucket to counterbalance the weight of the clamp and pulley assembly so that the sample material is held upright. Record the position of the wire pointer on the ruler. This is the zero force measurement. Gradually add measured weights to



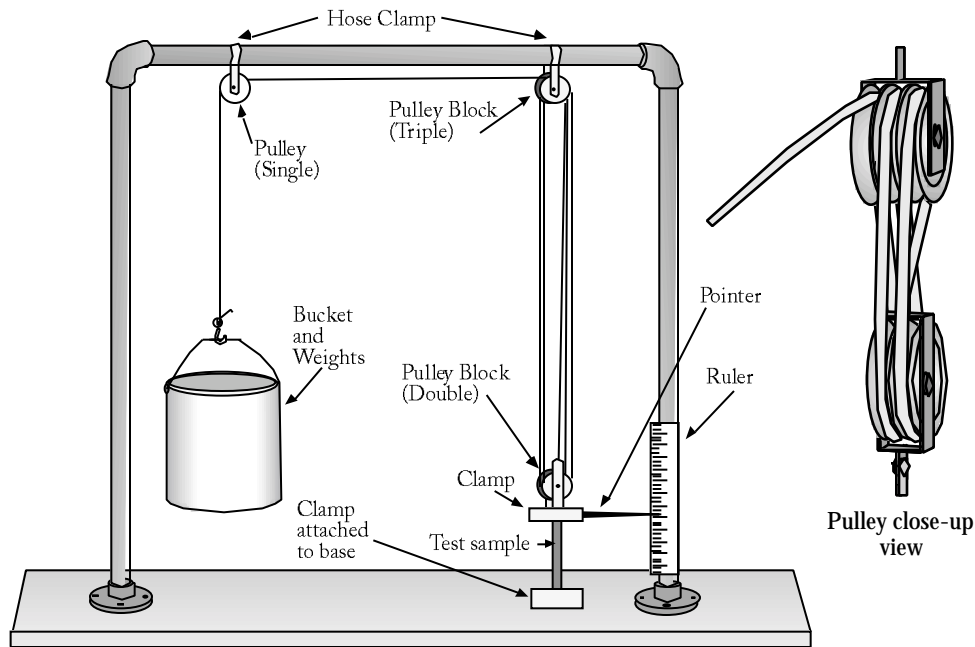

the bucket. The mechanical advantage of the pulley arrangement magnifies the actual pull (tensile force) on the sample five times. Record the tensile force (the weight in the bucket multiplied by five) and the position of the pointer. The position of the pointer indicates how much the fabric stretches as the force increases. Add more weight and record the data. Continue this process until the sample breaks or you run out of weights. Create a graph to demonstrate the performance of the material.

- The test stand can be modified for other materials tests.
- Students should wear eye protection when operating the apparatus.
- Details on how to attach the clamps to the apparatus have not been provided because of the variety of clamping devices that could be used. Students building the apparatus will have to determine how this is done.

Tips

- An empty metal gallon-size paint bucket can be used to hold the lead weights.
- Used wheel-balancing lead weights can be obtained free or for little cost at tire stores.
- In some materials, tensile strength varies with the direction the force is exerted. Compare cut crosswise to the grain and on the bias.
- For very strong fabrics (e.g. Kevlar®) test a narrower strip or even single strands and extrapolate the results to the force a one-centimeter wide piece could withstand.

Extensions

- Contact manufacturers of "high-tech" fabrics and fibers for specification sheets on the properties of their products. Some manufacturers may have web sites on the Internet. Conduct an Internet search using terms such as Kevlar® and Nomex®.
- Visit a sail maker's shop to learn about materials being used for sail construction and how fabrics are stitched together for maximum strength.
- Learn about how fabrics are manufactured and how different properties are achieved through fiber choice, weaving techniques, and coatings. Check for videotapes in school video catalogs.



Teacher Tech Brief

Impact Resistance Tester

Graphic

One of the hazards of spacewalking is the presence of small high-speed particles. These particles are called micrometeoroids and usually are smaller than a grain of sand, have a mass that is only a fraction of a gram, and travel at speeds ranging from a few to as many as 80 kilometers per second. An astronaut struck by a micrometeoroid could be severely injured. Furthermore, the near-Earth space environment has the additional problem of space debris such as paint chips and metal fragments from old rocket boosters and satellites. Being struck by one of these particles is equally dangerous. As a consequence, spacesuits have to be constructed from materials that are resistant to impacts.

Purpose

This test stand measures the resistance of sample materials to impacts.

Principle

The test stand consists of a tower, made from pipe, with an electromagnet near the top. A center punch (impactor) is suspended from the magnet and drops when the electricity is cut off. The center punch falls into a test sample placed below.

Materials and Tools Checklist

- Wooden base (6" x 1" x 2')
- PVC plastic water pipe (3/4" x 10')
- Pipe elbows (2 pcs)
- Pipe flanges (1 pc)
- Screws for flange
- Bell wire
- Large eye screw
- Electronic project box
- On/off switch
- Pilot light
- Push button switch
- 6 volt battery holder
- Wooden block (1" x 6" x 6")
- Center punch
- Screw driver
- Meter stick
- Test materials
- Tape or pins

Operation

Cut the material to be tested into a small square and tape or pin it on the test surface block (1" x 6" x 6" wooden block). After positioning the test material, turn on the electromagnet and attach the impactor.



Mathematics Equations

In physics, the energy of a moving object is called kinetic energy. The amount of that energy is related to the object's mass and its speed. The equation below can be used to determine the kinetic energy of the falling center punch at the moment of its impact on the test surface. The answer will be in joules (unit of work equal to a force of one Newton exerted over a distance of one meter; in English units, a joule is approximately equal to 0.75 foot pounds).

$$KE = 1/2 mv^2$$

m = mass of impactor

v = velocity at impact

To determine the velocity at the impact, use the following equation:

$$v = gt$$

g = the acceleration of gravity or 9.8m/second²

t = length of time the impactor fell

To determine the length of time the impactor falls, use the following equation:

$$t = \frac{\sqrt{2d}}{g}$$

d = the distance the impactor fell, in meters

Sample Problem

d = 2 m

Impactor mass = 50 grams

What is KE?

v = 9.8m/s²

x 0.64s = 6.3m/s

KE = 1/2 x 0.05kg x (6.3m/s)² = 1.19 joules

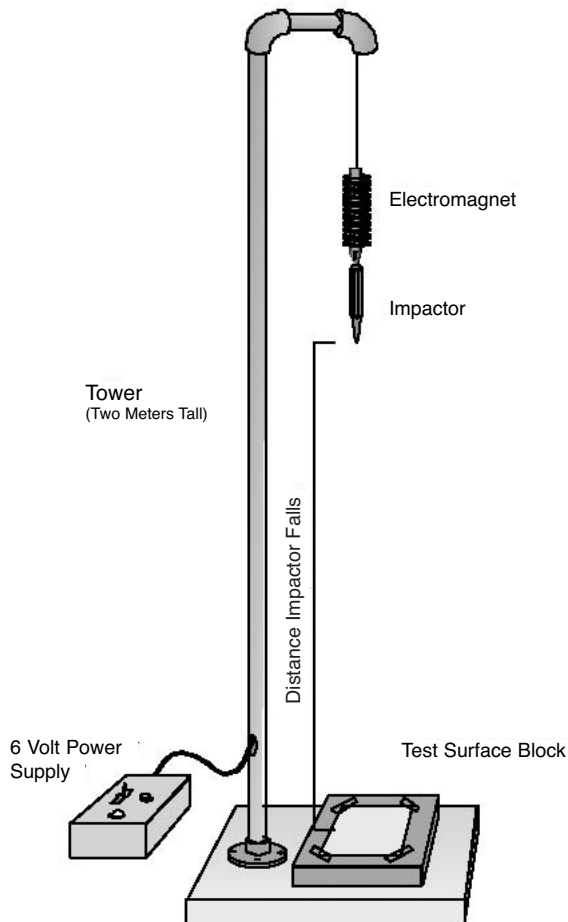

Measure the distance between the point of the electromagnet and the test material. When the impactor and magnet stop swinging, turn off the electric current to release the impactor. As it falls, the impactor will accelerate into the sample and make a dent or even penetrate it. Evaluate the resistance to impacts of various materials by comparing the damage done to them. Use a metric ruler for measuring the diameter of the dent or hole.



Special Note

In this simulation of micrometeoroid impact we are substituting an impactor with a large mass and low velocity for a micrometeoroid with a small mass and a high velocity. The reason for this can be seen in the first two equations on the previous page. Velocity is a quadratic factor while mass is a linear factor. Because of this trade, we can achieve similar damage to the surface of a material being impacted. However, micrometeoroids usually vaporize upon impact. If the surface layer is penetrated, the gas produced disperses on the material beneath.

Safety Precautions

1. All operators and observers must wear eye protection during drops.
2. The materials to be tested should be placed on the test stand before the impactor is suspended from the electromagnet. Nothing but the material to be tested should be under the suspended impactor.

Wiring Diagram for Power Supply

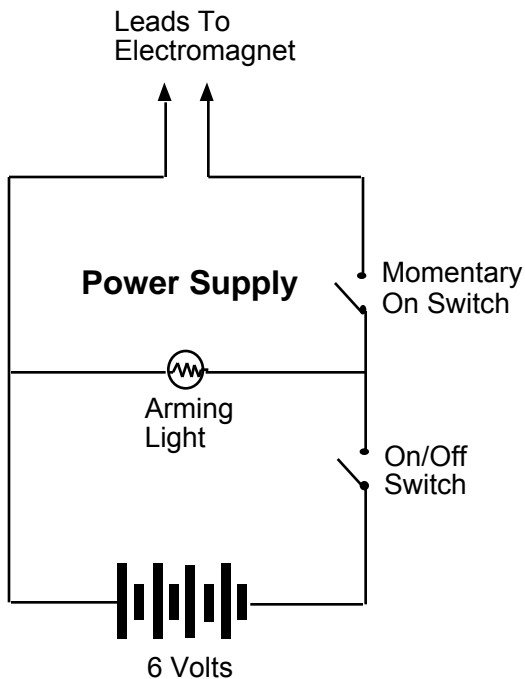

Tips

- Parts for the impactor design pictured in this activity are available from hardware stores (pipe parts, screws, eye screw, center punch) and electronic parts stores (project box, switch, battery holder, pilot light, electromagnet wire).
- Make your electromagnet by wrapping electromagnet wire about 400 times around a large eye screw. When the magnet is electrified the blunt end of the impactor will be held by the magnet. When the current is turned off, the magnet impactor will drop straight to the target.
- Have students bring in various materials for testing such as fabrics and plastics. Encourage students to create composite materials by combining two or more materials together.
- Ask students to keep a test log containing data from each test. Encourage students to predict the amount of damage a sample will receive during a test and compare that to the actual results.
- Discuss the relative merits of the materials the students tested. For example, a thick layer of

Finished Power Supply

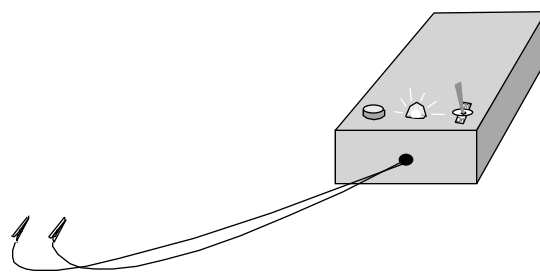

steel would make an excellent micrometeoroid shield but would probably be too heavy and too inflexible to be of use in a Martian suit.

- Before running tests on impact resistance, use Exploration Brief on Micrometeoroids and Space Debris (p. 67) with the students to introduce the topic of spacesuits and impacts. After your students have selected materials for their spacesuit, challenge them to wrap a potato in their materials and see if the materials prevent penetration in the drop test. Refer to the potato astronaut activity for more information.
- A typical micrometeoroid has a mass of 1×10^{-5} grams and travels at about eight kilometers per second. Upon impact, approximately three joules of work is expended.
- A drop tower is not necessary for this test. The electromagnet can be suspended from a pulley from the ceiling. The tower, however makes the unit very portable and eliminates any hazards associated with attaching a pulley to a high ceiling.
- For younger students, begin studying the mathematics of the device with observations

on the speed of the impactor as it falls. It will be observed that the farther the impactor falls, the faster it falls.

Extensions

- The impactor can be dropped from any height when testing materials. At what height should the impactor be suspended to equal the impact of a micrometeoroid in space if the micrometeoroid has a mass of 1×10^{-5} grams and a velocity of 8,000 meters per second? Velocity of 16,000 meters per second? (Your answers will depend upon the mass of the impactor you use.)
- How much kinetic energy is expended by the micrometeoroid above?
- Challenge the students to combine the equations on the previous page into simpler mathematical statements.
- How high should the impactor be before dropping to simulate the impact of a micrometeoroid with a mass of 1×10^{-5} grams and a velocity of eight kilometers per second? How high should the impactor be suspended if the micrometeoroid's velocity is 16 kilometers per second?



Teacher Tech Brief

Abrasion Tester

Background

Many years before Apollo astronauts walked on the surface of the Moon, some scientists speculated that lunar dust might pose a significant hazard. Dust accumulations in old craters could be quite deep and swallow up an unsuspecting astronaut that tried to cross one. Lunar Surveyor spacecraft that landed on the Moon prior to the Apollo expeditions showed that lunar dust (called regolith or sediment) had only accumulated to the depth of a few centimeters and therefore could not swallow up astronauts. This did not mean that the sediment was completely safe. Rather, the fineness of the sediment could pose a different kind of hazard—fouling equipment and suit components. Viking landers on Mars in the middle 1970s and the recent Pathfinder/Sojourner mission showed that Mars also has a sediment coating that could foul equipment and suit components of future Martian explorers.

Today, it is possible to study the effects of lunar sediment on materials because the Apollo astronauts returned home with samples. Rather than consume valuable lunar sediment samples on materials tests,

analysis of the sediments permitted scientists to create simulated lunar sediments to use in experiments. Based on Viking studies of Mars and the discovery of Martian meteorites in Antarctica, scientists have also created simulated Martian sediments. Both simulants have been used in a variety of tests, such as fabric abrasion and penetration of bearing seals. Since astronaut stays on the Moon were limited to a

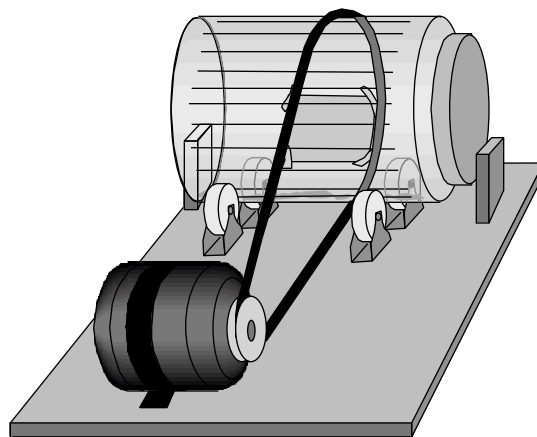

day or two, Apollo spacesuit materials only had to survive 10 to 20 hours of use. Future Martian explorers, however, will remain on the planet for many months to a year or more, and their suits will need to be constructed of rugged materials.

Purpose

This apparatus will measure the abrasion of fabrics and other suit materials exposed to simulated Martian sediment.

Principle

Test samples are placed in a rock tumbler or a specially constructed tumbler similar to the one shown on the preceding page. Simulated Martian sediment is placed in the drum and the rotating motion causes the sediment to abrade the samples.

Materials and Tools Checklist

- Wooden base (12" x 24" x 1")
- Electric motor with pulley (use motor with low rpms)
- Pulley belt
- Plastic food jar (1 gallon)



Fabric abrasion tester in use at the NASA Johnson Space Center. The white drum contains an inflated cylinder made from the outer fabric of a spacesuit. The drum also contains lunar sediment simulant. An electric motor with a pulley drives the drum.

- Four casters
- Wood block stops
- Fabric samples
- Masking tape
- Martian sediment simulant

Operation

The device shown on the previous page is a home-made rock tumbler. It is constructed from a plastic jar of the kind supplied to cafeterias and restaurants with various food stuffs such as relishes or mayonnaise. A motor, pulley, and rubber band belt rotate the jar. The jar rests on inverted casters and is held in place with stops at the ends. Squares of fabric samples are taped to the inside walls of the jar and a measured quantity of Martian sediment simulant is placed in the jar. The jar is allowed to rotate for a day or two and the fabric samples are removed for comparison with fresh samples. Reddish-brown volcanic rock used for landscaping can be used for making Martian sediment simulant. Bags of the rock will have small amounts of abraded sediment at their bottoms or you can crush the rocks to a fine soil-like material. Be sure to wear eye protection and gloves. Use a hammer to smash the rocks. Sort out and discard the larger pieces to leave just the sandy to powdery material behind.

Tips

- Look for an electric motor at an electric parts store. It may also be possible to find a suitable motor in an old appliance. Casters can be obtained at a hardware store.
- Examine fabric samples for signs of wear such as tears and holes. If a sample is opaque, place it on the lighted stage of an overhead projector to look for holes and thin areas.
- If solid materials are to be tested, do not test fabrics at the same time. The solid materials may damage the fabric, making it difficult to interpret the results.
- Estimate the number of rotations of the "rock tumbler" jar by counting how many times the jar





Apollo 16 astronaut Charles M. Duke Jr. samples lunar regolith (sediment) next to the "house rock" in the lunar Descartes highlands. Very fine sediment clings to his suit.

rotates in one minute. Multiply the number of minutes the jar has been rotated by the number of rotations per minute.

- More student interaction with the activity can take place if the motor-driven apparatus is replaced with just a jar. Each day for a week or two, students spend a few minutes shaking and rotating the jar and counting the number of times.

Extensions

- Devise testing procedures to measure the abrasion of the fabric on fabric in places on the space-suit where fabric rubs against itself (underarms, crotch, etc.).

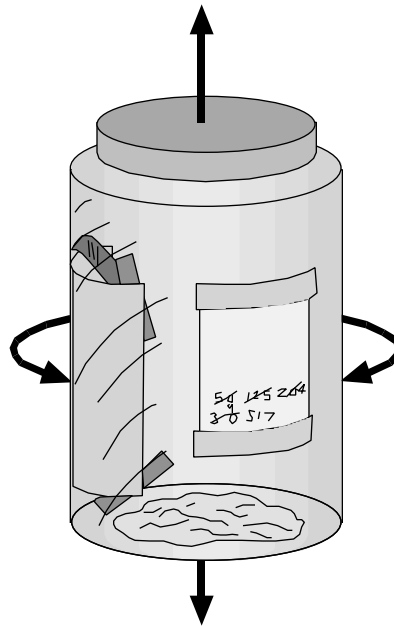

NASA Spacesuit Test Apparatus

In addition to laboratory versions of the testing apparatus described in the Teacher Tech Briefs, NASA spacesuit engineers also employ the apparatus shown on these two pages.

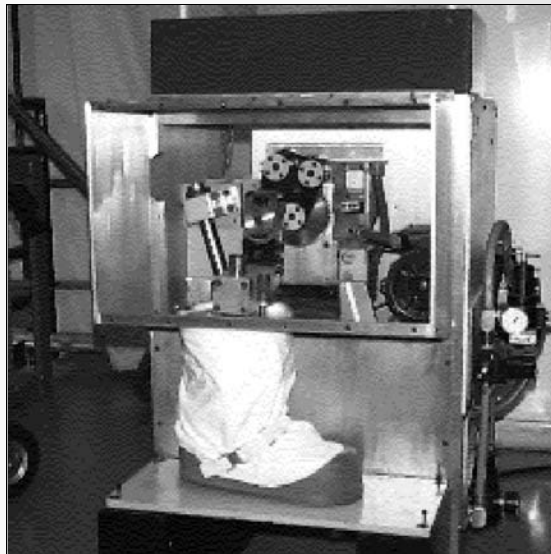

Mechanical Boot Tester
Checks boot performance with a walking motion.

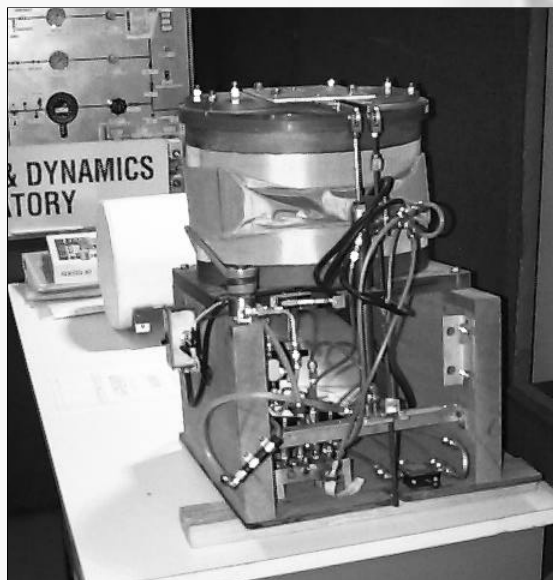

Waist Bearing Tester
The waist bearing is placed through a series of bends by this device.

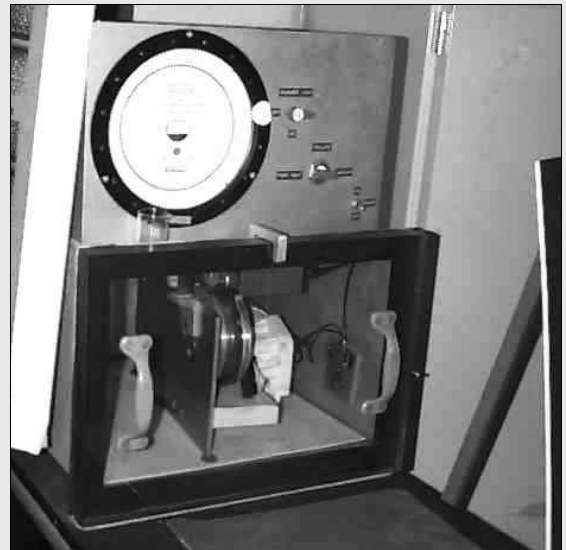

Bearing Tester
Bearings and other joints are subjected to simulated lunar sediment to find out if the sediment degrades their performance. The wrist bearing inside the unit is rotated as simulated lunar sediment is poured over it. The white device in the tester is a windshield wiper motor that rotates the bearing.



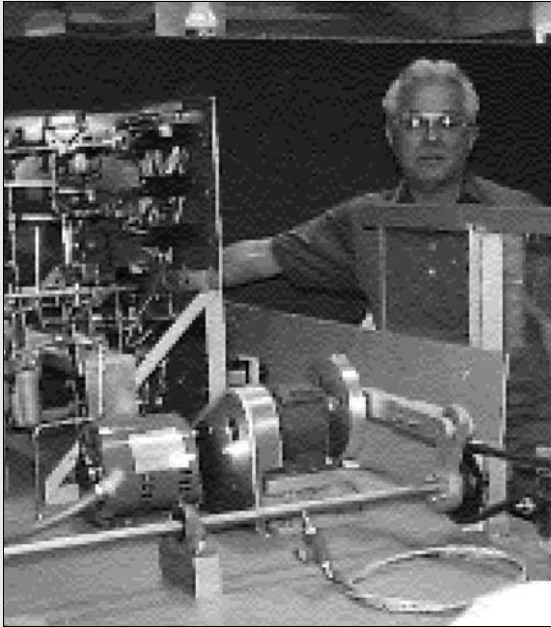

Sleeve and Leg Tester
Inflated segments of sleeves and legs are bent repeatedly by this device.



Spacesuit Robot
The forces required to move suit arms and legs when the suit is pressurized are measured with this specialized robot. The robot is placed inside a suit. A gasket seals the neck of the suit. The suit is then pressurized through the robot's "head." Joints in the arm and leg of the black side of the robot are bent on command and the forces are measured. The white side of the robot is non-functioning. Only one side of the robot is needed for data and the white side serves only as balance.



Exploration Brief

Different Gravity

Context

Gravity is an attractive force that all objects have for one another. It doesn't matter whether the object is a planet, a cannon ball, a feather, or a person. Each exerts a gravitational force on all other objects around it.

The amount of the gravitational force between two objects is directly proportional to the product of their two masses and inversely proportional to the square of the distance between their centers of mass. This relationship is expressed in the equation below. M_1 and M_2 are the respective masses of the two objects and r is the distance between their centers of mass. G is the gravitational constant.

$$f = G \frac{m_1 m_2}{r^2}$$

By referring to this equation, we can see that the force of gravity is not constant. The amount depends upon local conditions. For example, an astronaut walking on the surface of the Moon would weigh only 1/6th what he or she would weigh on the surface of Earth. That same astronaut

would weigh about 2/5ths as much on the surface of Mars. The reason for the difference is that the Moon and Mars are less massive bodies than Earth and they have smaller radii. Less mass reduces the amount of gravity experienced on the surface of the Moon and Mars while the smaller radii increases it.

Besides being altered by mass and distance, our perception of gravity's pull can also be altered by motion. Gravity can be made to appear to increase by accelerating away from Earth, as in a rocket liftoff or by riding on a centrifuge. Gravity can be made to appear to decrease by falling. NASA calls the environment created by falling microgravity.

You can get an idea of how this works by looking at the diagram on the next page. Imagine riding in an elevator to the top floor of a very tall building. At the top, the cables supporting the car break, causing the car and you to fall to the ground. (In this example, we discount the effects of air friction on the falling car.) Since you and the elevator car are falling together, you feel like you are floating inside the car. In other words, you and the elevator car are accelerating downward at the same rate due to grav-



ity alone. If a scale were present, your weight would not register because the scale would be falling too. The ride is lots of fun until you get to the bottom! NASA calls this floating condition microgravity. The condition is experienced in orbit and in transit between planetary bodies.

Astronauts experience many different gravity environments during space travel and these environments make different demands on the spacesuits they wear. When designing a spacesuit, it is important to know in which gravity environments the suit will be worn. For example, greater strain will be placed on fluid pumping systems if

the pump has to work against gravity than if it works in a microgravity situation. On an Apollo Moon landing mission, spacesuits were worn during liftoff when high G (gravity) forces were felt because of the acceleration. The suits were worn during lunar walks where the gravity was 1/6th that of Earth's gravity. Finally, the suits were worn in a microgravity environment during spacewalks while they coasted back from the Moon. Space Shuttle spacesuits are worn only in microgravity during space walks in Earth orbit. Suits worn on the surface of Mars may have to be modified to function in the 2/5ths g that will be experienced there.

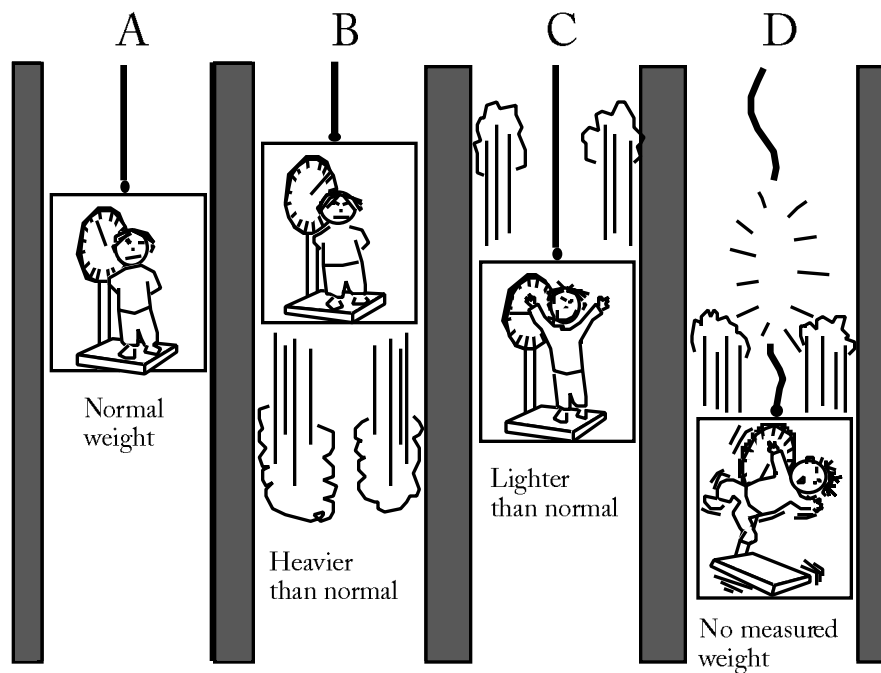

(A) The person in the stationary elevator car experiences normal weight. (B) In the car immediately to the right, weight increases slightly because of the upward acceleration. (C) Weight decreases slightly in the next car because of the downward acceleration. (D) No weight is measured in the last car on the right because of freefall.



Investigation: Creating Microgravity

Microgravity is easy to create. It is merely a matter of dropping objects. By falling, gravity's local effects are greatly reduced. That means that if two objects are falling together, gravity's influence on them becomes nearly zero. For example, if a heavy weight is suspended from an elastic cord, the cord will stretch out. If the cord is released, the weight and cord begin to fall to the floor. With gravity's effects greatly reduced, the cord immediately retracts to its relaxed length. The following activities are methods of creating microgravity in the classroom.

Materials and Tools Checklist

- Paper cup
- Masking tape
- Rubber band (thin)
- Several washers or nuts
- Scissors

Objective

- To investigate microgravity.

Procedure

- Step 1. Cut the rubber band and tie one end to the nuts or washers. The nuts or washers should be heavy enough to stretch the rubber band when suspended from the free end.*
- Step 2. Tape the free end of the rubber band to the inside of the cup.*
- Step 3. Hold the cup upside down. Slowly turn the cup right side up so that the nuts or washers hang outside the cup.*
- Step 4. Drop the cup to the floor from eye level. Observe what happens to the weights.*
- Step 5. Discuss the implications of microgravity on spacesuit design. For example, how can fluids (water cooling system, gas circulation, etc.) be moved in microgravity?*

Extensions

- Challenge students to come up with a way of simulating the 2/5ths gravity of Mars.
- Obtain a copy of the NASA curriculum supplement *Microgravity—Activity Guide for Science, Mathematics, and Technology Education, EG-1997-08-110-HQ*. The guide contains plans and instructions for several additional microgravity demonstrations.

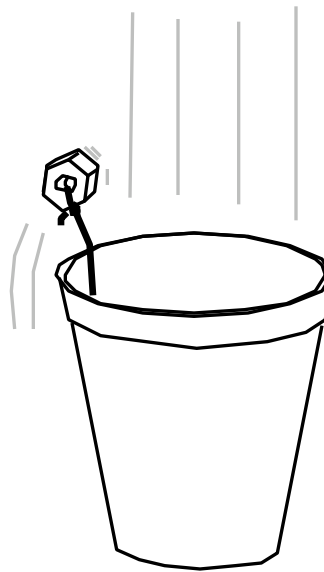

E xploration Brief

Micrometeoroids and Space Debris

Context

Astronauts on spacewalks are likely to encounter fast-moving particles called meteoroids. A meteoroid is usually a fragment of an asteroid consisting of rock and/or metal. It can be very large with a mass of several hundred metric tons, or it can be very small—a micrometeoroid which is a particle smaller than a grain of sand. Micrometeoroids are usually fragments from comets. Every day Earth's atmosphere is struck by millions of meteoroids and micrometeoroids. Most never reach the surface because they are vaporized by the intense heat generated by the friction of passing through the atmosphere. It is rare for a meteoroid to be large enough to survive the descent through the atmosphere and reach solid Earth. If it does, it is called a meteorite.

In space there is no blanket of atmosphere to protect spacecraft from the full force of meteoroids. It was once believed that meteoroids traveling at velocities up to 80 kilometers per second would prove a great hazard to spacecraft. However, scientific satellites with meteoroid detection devices proved that the hazard was minimal. It was learned that the majority of meteoroids are too small to penetrate the hull of spacecraft. Their impacts primarily cause pitting and "sandblasting" of the covering surface.

Recently spacecraft debris is of great concern to spacecraft engineers. Thousands of space launches have left many fragments of launch vehicles, paint chips, and other "space trash" in orbit. Most particles are small, but they travel at speeds of nearly 8,000 meters per second. These space-age particles have become a significant hazard to spacecraft and to astronauts on extravehicular activities.

Engineers have protected spacecraft from micrometeoroids and space trash in a number of ways, including thick-wall construction and multi-layer shields consisting of foil and hydrocarbon materials. A micrometeoroid striking multi-layer shields disintegrates into harmless gas that disperses on inner walls. Spacesuits provide impact protection through various fabric-layer combinations and strategically placed rigid materials.

Although effective for particles of small mass, these protective strategies do little if the particle is large. It is especially important for spacewalking astronauts to be careful when they repair satellites or do assembly jobs on the International Space Station. A lost bolt or nut could damage a future space mission through an accidental collision. (Note: Low orbit tends to be clearer of particles than higher orbits because low orbit particles tend to decay and burn up in the atmosphere.)



Investigation

Pea Shooter Meteoroids

The effects of high-speed micrometeoroid impacts can also be simulated with a "pea shooter." The shooter is actually a plastic milkshake straw. The projectile can be dried peas, popcorn, dried lentils, etc. The object of the activity is to penetrate tissue paper with the projectile. As with the Potato Astronaut activity, the velocity of the impactor determines the penetration.

Materials and Tools Checklist

- Plastic milkshake straw
- Dried peas, popcorn, etc.
- Tissue paper (for wrapping presents)
- Cardboard box
- Tape
- Eye Protection

Objective

- To compare the effect on tissue paper penetration between low and high speed projectiles.

Procedure

- Step 1. Cover the opening of a box with tissue paper. Stretch the paper tight.*
- Step 2. Drop a pea or other projectile from a distance of approximately 1 meter on to the tissue paper. Does the pea penetrate?*
- Step 3. While wearing eye protection, stand back a few meters from the box and blow the pea through the pea shooter at the tissue paper. Does the pea penetrate? (With a little practice, the pea should penetrate the paper.)*
- Step 4. Investigate what happens when more than one layer of tissue paper is used to cover the box opening.*

Safety Precautions

Students must wear eye protection. Caution students not to inhale through the straw.

Connections: Mathematics

Refer to the "Potato Astronaut–Part One" activity that follows.

Extensions

- Tape two straws end to end. Does that increase the velocity of the projectile?
- Experiment with projectiles that have a greater mass than the pea.
- Add a second layer of tissue paper to the box to see what effect the second layer has on penetration.
- Is there any relationship between the ability to penetrate the tissue paper and the distance the shooter stands from the box?

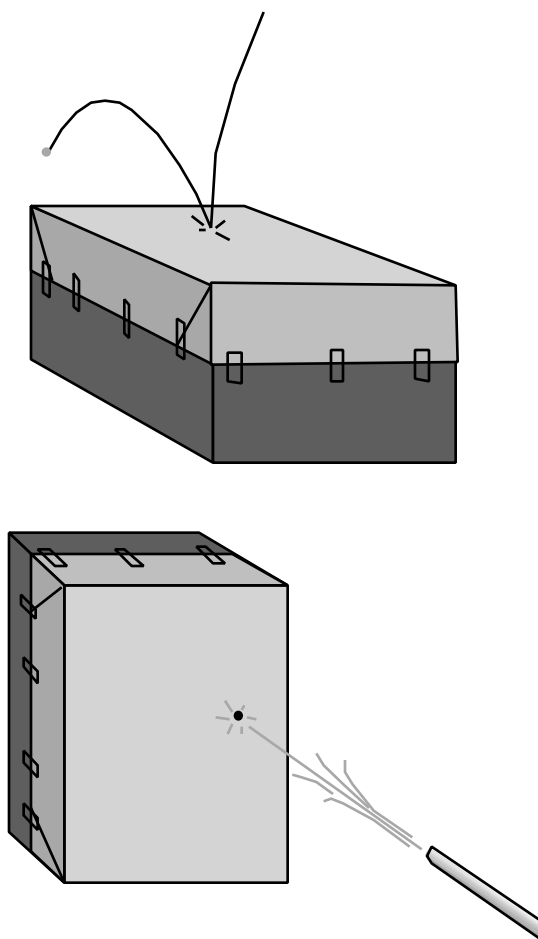

Investigation

Potato Astronaut—Part One

The effects of high-speed micrometeoroid impacts are simulated with a potato and a straw. Students hold the potato in one hand and stab it with the other using a plastic milkshake straw. The penetration depth into the potato relates to the speed of the stabbing action. A straw slowly pushed into the potato collapses. The plastic isn't strong enough to support the force exerted at the opposite ends of the straw. However, when the straw is thrust rapidly into the potato, the straw easily penetrates and passes through. The straw enters the potato before it has a chance to collapse. As it enters, the surrounding potato helps support the straw by shoring up its sides.

Materials and Tools Checklist

- Potato
- Plastic (milkshake-size) straw

Objective

- To investigate the relationship between velocity and penetration depth when a potato is struck with a plastic straw.

Procedure

- Step 1. Hold a raw potato in one hand. (See illustration.) While grasping the straw with the other hand, stab the potato with a slow motion. Observe how deeply the straw penetrates the potato.*
- Step 2. Repeat the experiment but this time stab the potato with a fast motion. Observe how deeply the straw penetrates the potato. Compare your observations with the results of step 1.*

Safety Precautions

Be careful to hold the potato as illustrated so that the straw does not hit your hand. Work gloves will provide additional protection.

Connections: Mathematics

The kinetic energy output of an impact, given in Joules, is calculated with the following equation:

$$KE = 1/2mv^2$$

m = mass of impacting object

v = velocity of impacting object

Note: The mass in this activity is actually the combined mass of the straw and the hand and forearm driving it.

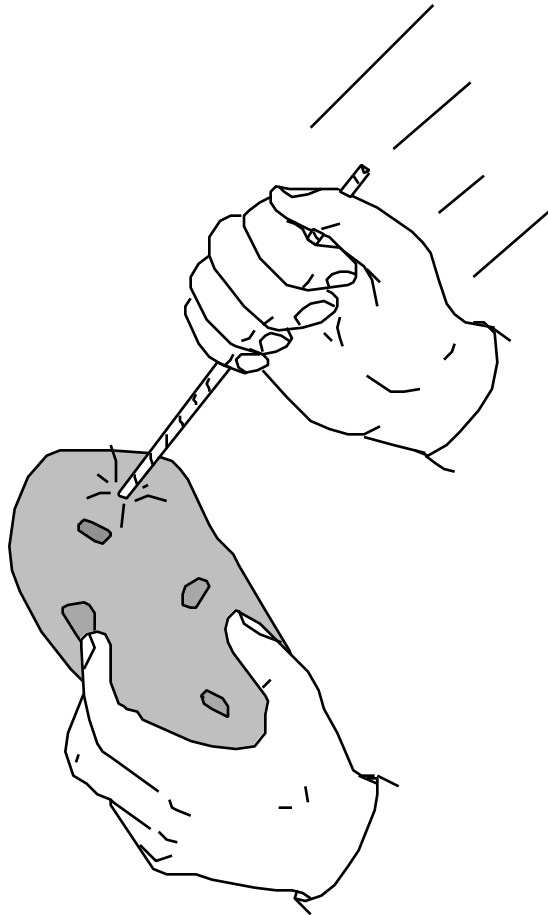

Investigation

Potato Astronaut—Part Two

In part one of Potato Astronaut, students found that "high speed" impacts enabled the plastic straw to penetrate the potato without collapsing. Challenge the students to design a way to protect the potato from damage caused by impacts using just the materials they brought to the classroom. Their solutions to the challenge should be flexible and light in weight.

Materials and Tools Checklist

- Plastic (milkshake-size) straw
- Potato
- Tissue paper, notebook paper, handkerchiefs, rubber bands, napkins, aluminum foil, wax paper, plastic wrap, etc.
- Impact Resistance Test Stand (from Teacher Tech Brief)

Procedure

- Step 1. Students design a method for protecting potato astronauts from damage caused by the plastic straw when the straw is quickly stabbed into the potato.*
- Step 2. After students have tested a method for protecting a potato, conduct a discussion to evaluate technologies developed. Refine the constraints for a protection system (e.g. the materials used must together be no thicker than ___ mm).*
- Step 3. Have students redesign their system based on the refined constraints. Conduct additional impact tests with the straw.*
- Step 4. Test protection systems by using the an Impact Resistance Test Stand as described in the Teacher Tech Brief found earlier in the guide. Evaluate the effectiveness of the protection systems developed.*

Extensions

- Compare technologies for protecting astronauts from micrometeoroid and space debris impacts to other protective technologies such as bullet-proof vests, suits of armor, shields on power tools, and windshields on vehicles. How does the function determine the form? (e.g. Motorcycle helmet—provide protection during crash . . . be streamlined . . . comfortable to wear . . . protect face from bug and rock impacts, etc.)
- Experiment with different fabrics and fabric combinations for protective garments.



E xploration Brief

Keeping Your Cool

Context

It is not sufficient for the health and well-being of an astronaut just to be protected from the hazards of the environment in which he or she is trying to work. It is also necessary to consider the conditions that are created by the suit itself. One of the most important of these conditions is temperature. Suit insulation technologies protect the astronaut from extreme high and low temperatures of the space environment. However, the same insulation technology also works to keep heat released by the astronaut's body inside the suit. To get an idea of what this is like, imagine walking around in summer wearing a plastic bag. For this reason, an active cooling system is employed.

In Space Shuttle Extravehicular Mobility Units or EMUs, the cooling system consists of a network of small diameter water circulation tubes that are held close to the body by a Spandex® body suit. Heat released by the astronaut's body movements is transferred to the water where it is carried to a refrigeration unit in the suit's backpack. The water runs across a porous metal plate that is exposed to the vacuum of outer space on the other side. Small amounts of water pass through the pores where it freezes on the outside

of the plate. As additional heated water runs across the plate, the heat is absorbed by the aluminum and is conducted to the exposed side. There the ice begins to sublimate, or turn directly into water vapor and disperses in space. Sublimation is a cooling process. Additional water passes through the pores, and freezes as before. Consequently, the water flowing across the plate has been cooled again and is used to recirculate through the suit to absorb more heat.

Supplementing the EMU cooling system is an air circulation system that draws perspiration-laden air from the suit into a water separator. The water is added to the cooling water reservoir while the drier air is returned to the suit. Both the cooling system and the air-circulation system work together to contribute to a comfortable internal working environment. The wearer of the suit controls the operating rates of the system through controls on the Display and Control Module mounted on the EMU chest.

Objective

- To investigate and experience the way the water cooling system in the Space Shuttle EMU functions.



Investigation

Water Cooling—Part One

This demonstration shows the principle behind the operation of the Space Shuttle EMU liquid cooling garment. Instead of an internal heat source (the suit wearer), the heat is provided by a strong electric light bulb or flood lamp.

Materials and Tools Checklist

- Two coffee cans with plastic lids
- 4 meters of aquarium tubing
- Two buckets
- Two thermometers
- Duct tape
- Water (solid and liquid)
- Heat source (light bulb and fixture)
- Hole punch
- Flood light and fixture

Procedure

- Step 1. Punch a hole near the bottom of the wall of a metal coffee can. The hole should be large enough to pass aquarium tubing through. Punch a second hole in the plastic lid of the can so that tubing can pass through it as well. Punch another hole in the center of the lid so that a thermometer will fit snugly into it. Finally, punch a hole in the center of the second coffee can lid for another thermometer.*
- Step 2. Loosely coil the aquarium tubing and place it inside the first coffee can. Use bits of tape to hold the coils to the walls and to keep them spread out evenly. Pass the lower end of the tube through the hole in the can wall and the upper end through the outer hole in the lid. The lower tube should extend to the catch bucket that will be placed below the can. The upper end will have to reach to the bottom of the ice water bucket. That bucket will be elevated above the can. Insert thermometers into each can.*

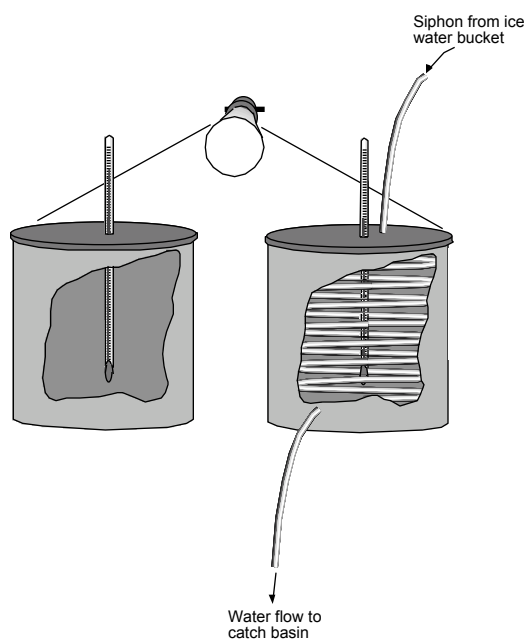

- Step 3. Place the two cans on a table top. Direct the light from a strong light bulb or flood light to fall equally fall on the two cans. The light should be no more than about 25 centimeters away from the cans. Fill a bucket with ice water and elevate it above the two cans. Place the catch bucket below the two cans.*
- Step 4. Turn on the light. Observe and record the temperatures on the two thermometers. After two minutes, again observe and record the temperatures.*
- Step 5. Place the upper end of the aquarium tubing into the ice water and suck on the other end of the tube to start a siphon flowing. Let the water pour into the catch bucket.*
- Step 6. Observe and record the temperature of the two cans at regular intervals for ten minutes.*

Tips

- If more than one student is going to start the siphons with sucking on the end of the tube, make sanitary mouthpieces like those called for in the activity "O₂ How Much?"
- Color the water with food coloring to increase its visibility in the siphons.



Assessment

Have students design a graph to display the data collected in step 6.

Extensions

• How can the flow of icy water be controlled? Find a way to maintain a constant temperature inside the can with the tubing. Move the light source closer to the can so that it is heated more than before. Try to maintain the internal temperature at the same level as before.

Investigation

Water Cooling —Part Two

This demonstration permits students to experience the water cooling technology used in the Space Shuttle EMU.

Materials and Tools Checklist

- Two buckets
- 3 meters of aquarium tubing
- Water (solid and liquid)
- Kitchen size plastic garbage bag (one per student)

Procedures

- Step 1. Distribute one plastic garbage bag to each student. Have students wearing long-sleeve shirts roll up one sleeve.*
- Step 2. Ask each student to place their bare arm inside the bag and then gather the plastic so that it fits closely along the entire length of the bag. Tell students to repeatedly make a fist or wave their arm while it remains in the bag for a for two minutes. (Steps 1 and 2 can also be done with plastic gloves.)*
- Step 3. After two minutes, have students remove their arms from the bags and observe any sensations that come with their removal. Discuss what students felt. Make sure they understand that a spacesuit, like the plastic bag, retains body heat. Also discuss why their arms suddenly felt cooler with the removal of*



the bags. (Warm air in the bag was released and moisture from perspiration began evaporating.)

- Step 4. Select a student volunteer for another experiment. Wrap the middle of the length of aquarium tubing around the bare arm of the volunteer several times.*
- Step 5. Start a siphon flow from the ice water bucket through the tube. Ask the student to describe for the rest of the class the sensations he or she feels. (See note about mouthpiece in part 1.)*

Extensions

- Discuss how a liquid cooling garment could be constructed that could operate continuously without siphons and buckets of ice water that eventually run out.
- What professions on Earth might find liquid cooled garments useful?
- Design and construct a liquid cooling garment out long underwear or Spandex® running tights.



Exploration Brief

Absorption and Radiation

Context

The temperature range of outer space and on planetary bodies is affected by a wide range of factors. In outer space, the temperature on a surface depends upon whether that surface is in sunlight and if so, the angle of that surface to the Sun's rays. On a planetary body, the temperature also varies with the ambient atmospheric temperature, winds, and nearby surface materials. For example, on Earth temperatures can vary dramatically on a summer day between asphalt parking lots and grassy borders.

When designing spacesuits, it is important to account for the temperature range of the environment for which the suit is intended. Heating and cooling systems inside a suit can moderate temperatures, but electric power to operate these systems limits the length of time the suit can be used before recharging. One way to reduce the dependency of a spacesuit heating/cooling system is to use materials for suit construction that have desirable thermal properties. If, for example, a suit is operated in a very cold environment, good insulating material will reduce the need for internal suit heating.

Materials and Tools Checklist

- Coffee cans with plastic lids
- Thermometers
- Flood lamp (optional)
- Various colors of paint
- Foil, construction paper, etc.
- Clock
- Refrigeration (see step 6)

Objective

- To investigate the effect different colors, reflective surfaces, and different materials on radiant heat absorption and heat radiation.

Investigation

Surface Color

This activity investigates the affect surface color has on heat absorption and radiation.

Procedure

- Step 1. Paint the surfaces of several coffee cans in different colors such as white, black, green, or yellow.*



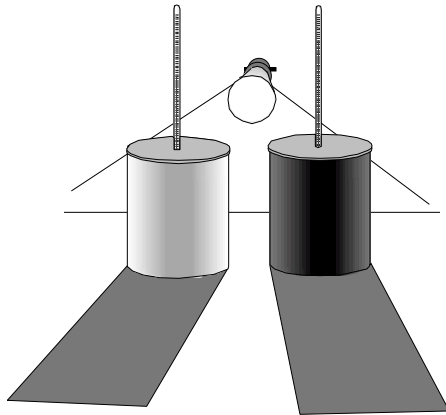

- Step 2. Punch a small hole in the plastic resealable lid and insert a thermometer bulb to approximately the middle of each can.*
- Step 3. Place the cans in sunlight so that all are equally exposed. Immediately record the initial temperature of each can. If you are doing the experiment inside, expose the cans to a flood light. It is important that each can receives the same amount of heat from the lamp. Measure and record the temperature of the cans every minute.*
- Step 4. Remove the cans from the heat source after 10 minutes and measure and record their temperatures again for the next 10 minutes. Graph your data. Relate the temperature rise and fall of each can to its surface color.*
- Step 5. Change the surface material of the cans by wrapping them with aluminum foil, gray construction paper, or cloth. Repeat the experiment to find the best combinations of colors and surfaces for different environments.*
- Step 6. Repeat the experiment by subjecting the cans to intense cold. The cans can be placed in a freezer or in a tub with ice water or a block of dry ice.*

Investigation

Insulating Layers

In this activity, students explore the insulative properties of several materials.

- Step 1. Stack different fabrics, paper, and foils, and fold them into small envelopes. Insert a thermometer and repeat the previous experiment to determine the heat absorption and reflection properties of different material combinations.*

Extensions

- Conduct chromatography experiments on various ink colors to see what their component colors are. Black inks often consist of several colors. The reason for mixing several ink pigments is to make a darker black (more complete absorption of light). (The Space Shuttle uses black heat shield tiles on the bottom of the orbiter to quickly dissipate the heat produced when reentering Earth's atmosphere.)

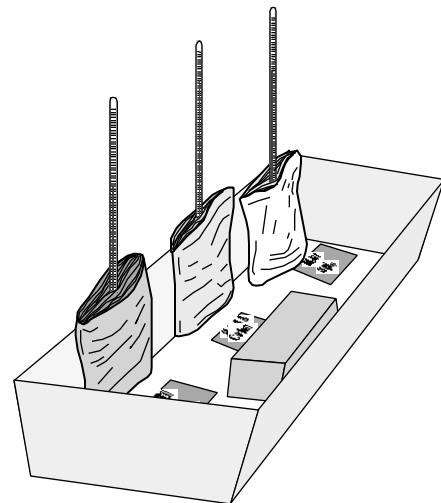

E xploration Brief

Getting the Right Fit

Context

In spite of many decades of experience in developing and evaluating spacesuits, they are still fatiguing to wear. The internal pressure of the suit creates resistance to movements of the arms, hands, or legs. Consequently, astronauts training for a spacewalk are encouraged to stay in excellent physical condition by training on the ground for endurance and strength. After a spacewalk, crew members are allowed a day of rest before going out again. That is why missions, such as the multi-day servicing of the Hubble Space Telescope, have two EVA crews that alternate spacewalk days.

The exhaustion factor of spacesuits can be mitigated somewhat by insuring that the suit the crew member will wear in space fits properly. It is essential that the position of suit joints precisely match the position of shoulders, elbows, wrists, knuckles, knees, and ankles. A misalignment of a mere centimeter in the arm length, for example, can lead to aching fingers after a several-hours spacewalking.

Getting the right fit is complicated by a number of factors. It is important that the suit fits when it is

pressurized. An unpressurized suit is slightly smaller than when it is pressurized. The suit must fit right when the crew member is in space. The microgravity

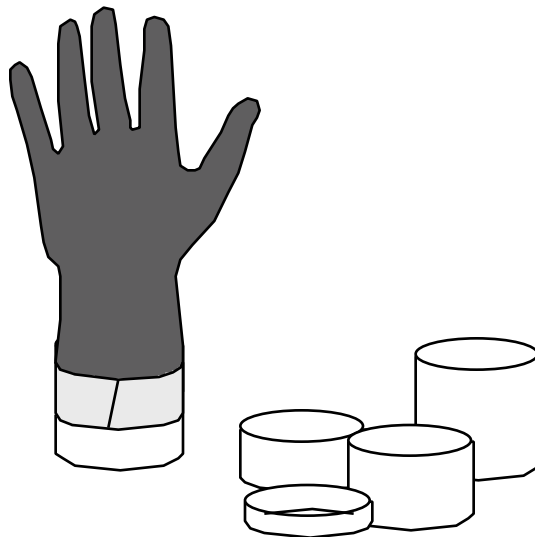

environment experienced in Earth orbit affects the human body in many ways. One effect is spine lengthening. In one G (gravity), the vertebrae of the spine are close together but are kept separate by rubbery disks that act as shock absorbers. In space, without the perceived directional force of gravity, the disks expand slightly, causing the vertebrae to move slightly farther apart than they are when the crew member is standing upright on Earth. This spine-lengthening causes the astronaut to get taller, resulting in arm joint misalignment. Spine lengthening in microgravity has to be accounted for when astronauts are measured for their suits. The typical astronaut will gain between 2 and 3 centimeters in height while in space.

To avoid the expensive and time-consuming process of creating custom-made suits for astronauts, as NASA did during the Apollo missions, suits with interchangeable parts are used. Different-sized upper and lower torsos are available, but arm and leg lengths are still difficult to match. NASA has solved this problem for the Shuttle EMU by creating sizing inserts that are added or removed from the restraint layer in the arms and legs to achieve the right fit. The inserts are fabric rings of different lengths that are laced into the arms and legs. Selecting the right combination of inserts insures the best fit possible.

Objective

- To experience the measurement process used in sizing a spacesuit arm to fit different wearers.

Materials and Tools Checklist

- PVC thin-wall sewer pipe (4 in. dia.)
- Saw (crosscut or hacksaw)
- Measuring tape or ruler (metric)
- Duct Tape
- Vinyl clothes-dryer hose
- Scissors
- Thick rubber gloves
- Sand paper or knife

Procedure

- Step 1. Construct a variety of spacesuit arm segments by sawing off measured lengths of PVC plastic thin wall sewer pipe. (See the tip section for information on where the sewer pipe and other needed materials can be obtained.) Cut the pipe into segments 25, 50, 75, and 100 mm long. Cut two of each size. Cut three additional segments of the 50 mm length.*
- Step 2. Create a suit elbow joint by connecting two of the 50 mm segments with a 25 cm piece of vinyl clothes dryer hose. Slip the hose ends over one end of each of the segments. It will be necessary to the hose a small amount to accomplish this task. Fasten the hose to the segments with duct tape.*
- Step 3. Slip the cuff of one of the gloves over a 50 mm pipe segment. The fit may be tight but try to slide the ring in so that it just reaches the position of the wrist. Trim off the excess of the cuff so that the glove can be affixed to the ring with duct tape.*

Activity

- Step 4. Provide the rings, joint, glove, measuring tape, and duct tape to a group of students. Tell the students to select one member of their group to serve as the astronaut. Their objective is to fit a suit arm to that astronaut. The students should begin by measuring the arm and mapping the range of movement of the arm without the suit. Use the Arm Range of Movement Data Sheet for recording data.*
- Step 5. The students should select the right combination of segments to use to construct the arm. PVC rings are joined with pieces of duct tape.*
- Step 6. After completing the arm, the student group should test it by placing the "astronaut's" arm into the suit arm. They will then evaluate the arm by repeating the range of movement tests done before and by asking the astronaut how comfortable the arm is to wear. If the fit is not comfortable or the range of movements are*



restricted, the student group should adjust the arm length by changing the lengths of the PVC rings used. When the fit is comfortable, and the range of movement is acceptable, record the sizing data in the log chart that is provided. The sizing process can be repeated with a different student.

Tips

- All the materials for this guide can be obtained at larger hardware stores. Pick a thin wall sewer pipe without holes in its sides. A 10 foot length of pipe is inexpensive and will provide material for several sets of arms.
- A long sleeve shirt worn by the astronaut will reduce any possibility of pinching skin between pipe segments.
- Use the saw to cut the sewer pipe. Have someone help you hold the pipe as you cut it. Use sandpaper or a sharp knife to remove burrs left on the pipe segments after sawing.
- Duct tape pieces can be removed and used again for joining segments. White duct tape can be substituted for gray tape to improve the appearance of the arms or one inch wide masking tape can be used.
- Actual arm measurements for spacesuit fitting involve more measurements than just arm length and range of movement of the extended arm in three planes. Other necessary measurements include upper and forearm circumference, hand and finger size, knuckle location, and movement of the forearm from the elbow.

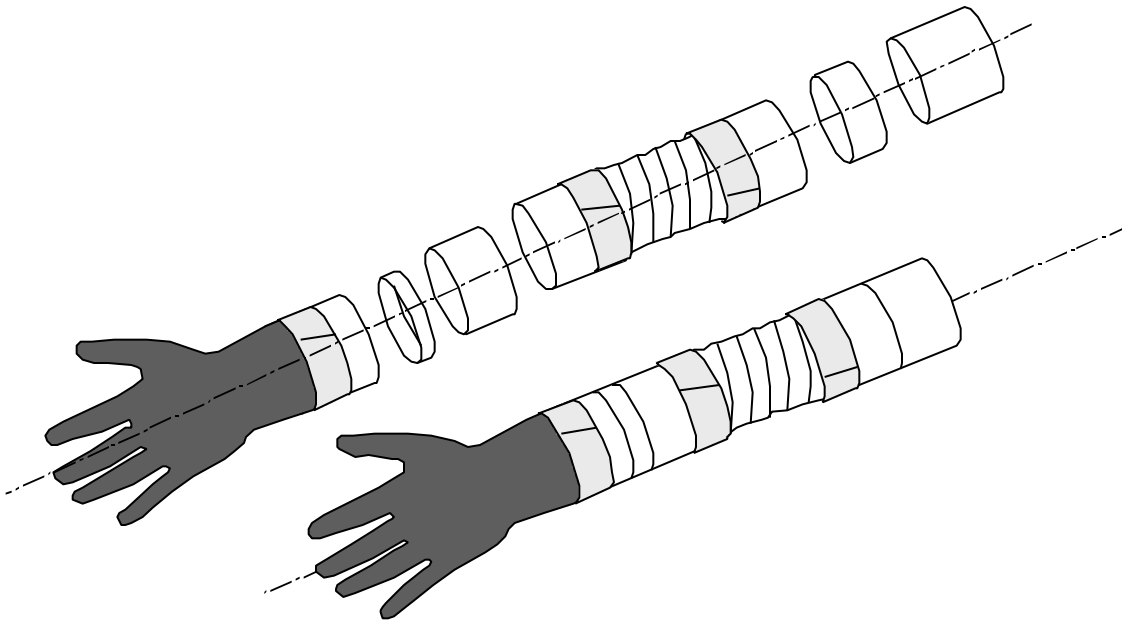

Arm Range of Movement Data Sheet

Subject Name: _____

Arm Length _____ cm (shoulder to elbow)

Arm Length _____ cm (elbow to wrist)

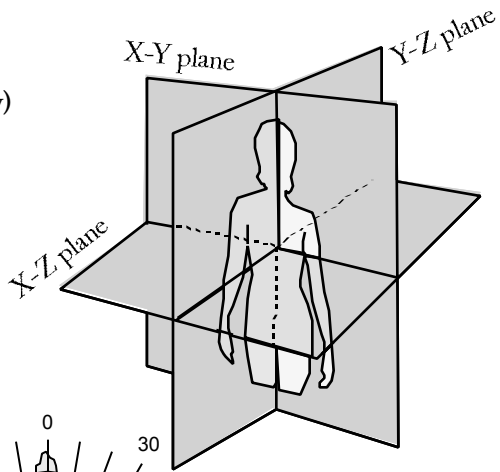

X-Z Plane Movement Range:

0 to + _____

0 to - _____

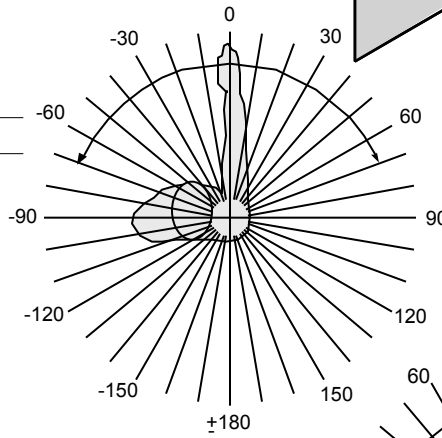

X-Y Plane Movement Range:

0 to + _____

0 to - _____

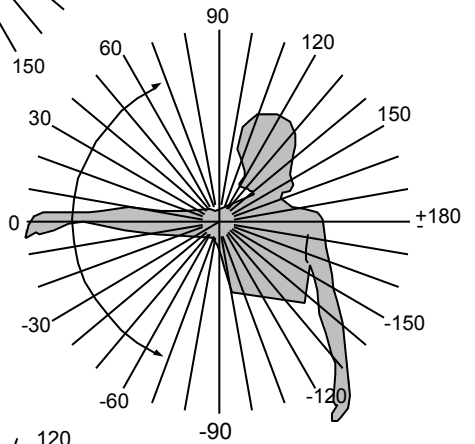

Y-Z Plane Movement Range:

0 to + _____

0 to - _____

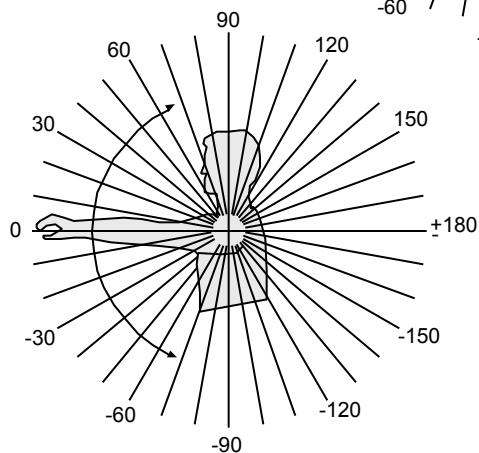

Extensions

- When fitting spacesuit components to astronauts, more than 100 measurements are taken. Set up a measuring activity with students and determine the class average for each measurement made. Because of certain sensitivities, you may wish to avoid girth measurements. Refer to the chart on the next page for data covering girth.

Measurements on the chart provide the range of measurements between the 5th percentile (40-year-old Japanese female) and the 95th percentile (40-year-old American male). These range measurements are projections to the year 2000 in a one-gravity environment.

- Create a computer spreadsheet to compile class data.

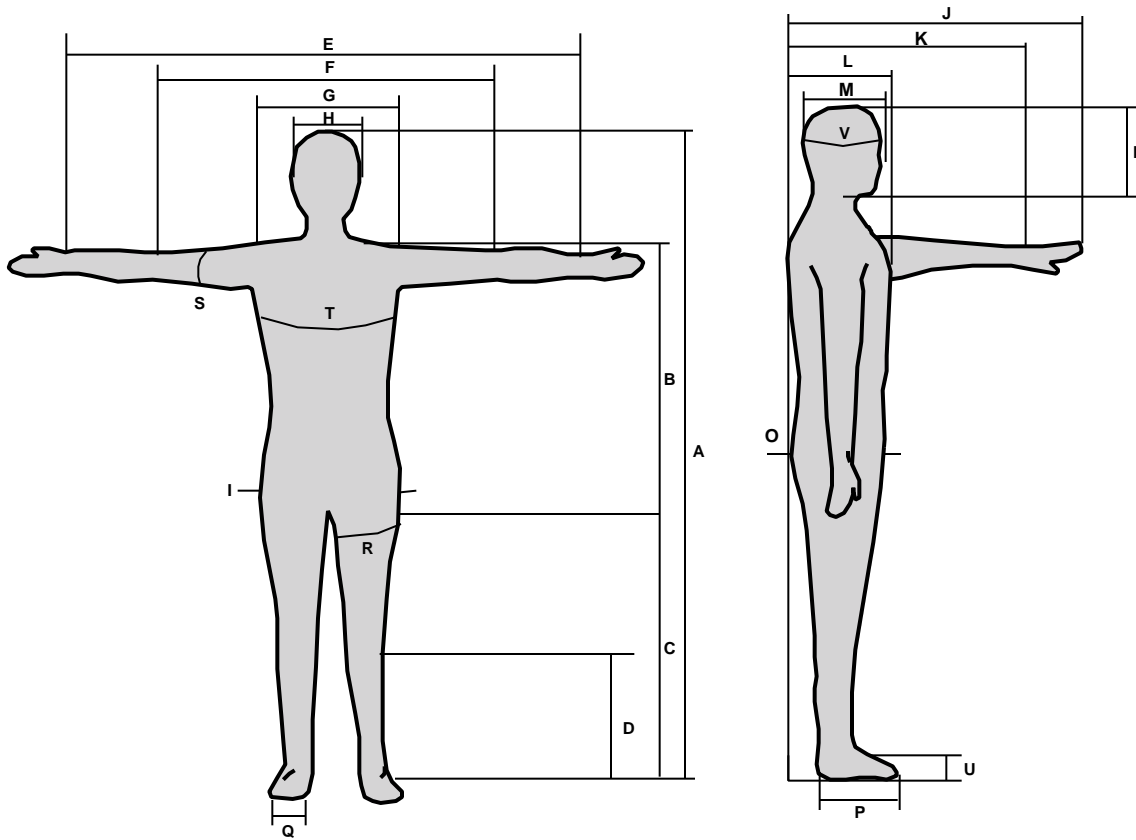

Body Size Range Measurements

Based on 1989 Man-Systems Integration Standards, NASA-STD-3000

Category	Minimum (cm)	Maximum (cm)
A. Stature*	162.1	187.7
B. Vertical trunk dimension	64.3	74.4
C. Crotch height	74.4	91.9
D. Knee Height	32.3	38.9
E. Wrist to wrist distance	131.6	167.1
F. Elbow to elbow distance	85.9	106.2
G. Chest breadth	27.9	36.6
H. Head breadth	12.7	16.5
I. Hip breadth	32.3	38.9
J. Arm reach	80.5	94.2
K. Shoulder to wrist reach	62.2	73.7
L. Chest depth	21.3	27.7
M. Head depth	18.3	21.6
N. Chin to top of head	21.8	24.4
O. Hip depth	24.1	29.2
P. Foot length	21.1	27.4
Q. Foot width	8.9	10.7
R. Thigh circumference†	52.1	67.1
S. Biceps circumference (flexed)	27.4	36.8
T. Chest circumference	89.2	109.7
U. Instep	NA	8.3
V. Head circumference	55.5	60.2

* Stature increases approximately 3 percent over the first three to four days in microgravity. Because almost all the change appears in the spinal column, other dimensions such as vertical trunk dimension increase proportionately.

† Thigh circumference will significantly decrease during the first day in orbit due to the shift of fluid to the upper torso.



E xploration Brief

O₂—How Much?

Context

A typical extravehicular activity (EVA) lasts about 7 hours. During that time, an astronaut performs a number of activities, some of which are very strenuous. To make it possible to accomplish the mission, the spacesuit has to provide a steady and reliable oxygen supply for breathing and suit pressurization. The oxygen supply in the primary life-support system (PLSS) is contained in four oxygen tanks. Two of the tanks are used as the primary oxygen supply and two for an emergency secondary supply. The two primary tanks each have a volume of 3,980 cm³. They contain a total of 0.55 kilograms of oxygen at a pressure of 5,860.5 kilopascals. As this oxygen circulates through the suit, it passes through a recycling system that removes carbon dioxide, odors, and humidity. The two secondary oxygen tanks have a volume of 1,460 cm³ and contain a total of 1.19 kilograms of oxygen at a pressure of 41,368.5 kilopascals. This supplies only enough oxygen for about 30 minutes because this oxygen is not conserved and recycled.

Although the Shuttle spacesuit is used in Earth orbit where the suit is in effect, weightless, the

oxygen tanks still have to be constructed from lightweight materials. Weight is not a problem in orbit, but it is a problem for Shuttle liftoff. The Space Shuttle can carry only so much mass to orbit. Lighter tanks means that additional payload can be carried.

To reduce their weight tanks are made from thin-wall metal shells that are wrapped with Kevlar® filaments and resin for strength.

Objective

- To measure the quantity of oxygen a person will need under varying levels of activity

Materials and Tools Checklist

- Two-liter soft drink bottle
- 1 meter of flexible plastic tubing
(from a hardware or aquarium store)
- Permanent marker
- Paper strips
- Cellophane tape
- Water
- Large pot or aquarium



Procedure

- Step 1. Obtain the materials in the material list and begin by calibrating the 2 liter soft drink bottle. Stand the bottle upright and pour measured amounts of water into the bottle with a beaker. Add 100 ml and mark the side of the bottle at the top surface of the water. Repeat this procedure until the bottle is filled.
- Step 2. Make paper mouthpieces by rolling a strip of paper around one end of the tube. Use a small strip of tape to hold the mouthpiece together. Make a new mouthpiece each time a different person uses the apparatus.
- Step 3. Partially fill a large pot or aquarium with water. Fill the bottle with water and invert it in the aquarium. Support the bottle by holding it with one hand around the neck. Insert the air hose into the bottle neck. Attach a mouthpiece to the other end of the tube and have a student fully exhale a normal breath of air through the tube. Water will be driven out of the bottle. Read the volume of air trapped inside the bottle from the calibration marks placed on the bottle's side in step 1.

Activity

- Step 4. Measure the air quantity required in normal breathing by several volunteer students. Begin with the students at rest. With a fresh mouthpiece on the tubing, have a student inhale a normal breath of air and exhale the air through the tube. The student should do this several times. Measure the amount of air in the bottle and divide this quantity by the number of breaths. Record the quantity for "at rest" on a data table or computer spread sheet. Also measure and record how long it took for the test.
- Step 5. After recording "at rest" breathing requirements, refill the bottle with water and have each student perform a moderate amount of activity such as lifting small barbells for a minute or two. After exercising, repeat the air

quantity requirement measurements and record the numbers in the data table for "moderate work."

- Step 6. Repeat the procedure a third time, but have the students run in place for a minute or two before taking the measurements. Record the results under "strenuous exercise."
- Step 7. Discuss possible ways to determine how much air an average "student astronaut" will need on a 7-hour spacewalk in which the work level will range from moderate to strenuous and calculate an answer from the data collected. Make sure the students realize that not only will the quantity of air taken in with each breath change but the breathing rate will change with exercise. Determine what the quantity would be if, instead of a normal air mixture, pure oxygen would be used. (Normal air contains 20 percent oxygen.)

Extensions

- Determine the actual volume of oxygen carried in the Shuttle spacesuit primary and secondary oxygen supplies. Oxygen, under standard conditions, has a mass of 1.327 kilograms per cubic meter. (The primary and secondary oxygen systems contain a total of 1.74 kilograms of oxygen. Divide that number by 1.327 to get the volume of oxygen in cubic meters. Although the volume may seem small, remember that oxygen is recycled.)

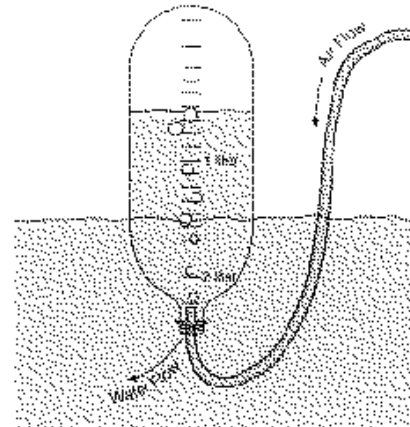

Exploration Brief

Keeping the Pressure On

Context

While pressure is essential to astronaut survival, the pressure exerted by a spacesuit does not have to match sea level pressure on Earth. If the atmosphere inside a spacesuit is pure oxygen, a pressure equal to about one third sea level pressure (about 33 kilopascals) is sufficient. However, such low pressures require a several hour oxygen prebreathing period to eliminate nitrogen from the spacewalker's blood stream. If a higher suit operating pressure can be achieved, an astronaut can don a suit and immediately exit the spacecraft for a spacewalk.

Operating pressures inside spacesuits are achieved by creating some sort of pressure shell around the astronaut. The shell can be made of rigid materials or a combination of fabrics provided they are nearly leakproof. The pressure layer of the Space Shuttle spacesuit encase the astronaut inside a human-shaped bag which has an inner layer of rubber and an outer layer of nylon. The rubber contains the atmosphere and the nylon prevents the rubber from inflating beyond a predetermined size and shape. Once the suit is fully inflated, additional gas pressure supplied to the suit pushes inward on the astronaut providing a livable pressure environment.

Objective

- To demonstrate one method for creating a workable pressure inside a spacesuit.

Materials and Tools Checklist

- 0.5 m ripstop nylon (available in fabric stores)
- Sewing machine
- Scissors
- Long balloon
- Bicycle pump with pressure gauge
- Small adjustable screw type, hose clamp
- Tire valve
- Screwdriver

Procedure

- Step 1. Using two pieces of ripstop nylon, stitch a bag as shown in the pattern on the next page. The pattern should be doubled in size. For extra strength, stitch the bag twice. Turn the stitched bag inside-out.*
- Step 2. Slip the nozzle of a long balloon over the fat end of the tire valve. Slide the other end of the balloon inside the bag so the neck of the tire valve is aligned with the neck of the bag.*



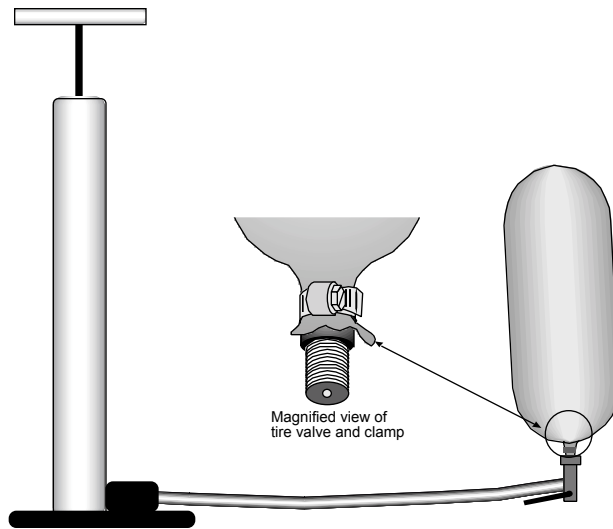

Step 3. Slide the adjustable hose clamp over the bag and tire valve necks. Tighten the clamp until the balloon and bag are firmly pressed against the tire valve neck. This will seal the balloon and bag to the valve.

Activity

Step 4. Connect the tire valve to the bicycle pump and inflate the balloon. The balloon will inflate until it is restrained by the bag. Additional pumping will raise the pressure inside the balloon. Check the tire pressure gauge on the pump (use separate gauge if necessary) and pressurize the bag to about 35 kilopascals (5 pounds per square inch). The tire valve can be separated from the pump so that the bag can be passed around among the students.

Step 5. Discuss student observations of the stiffness of the pressurized bag. square inch). What problems might an astronaut have wearing a pressurized spacesuit?

Extensions

- Compare the technology for pressurizing spacesuits to the technology for pressurizing automobile tires.

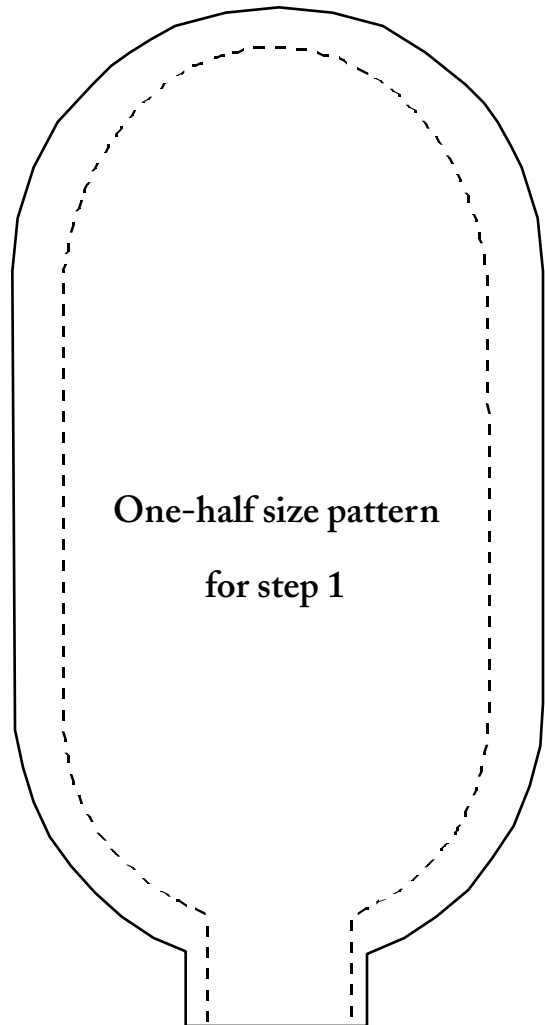

E xploration Brief

Bending Under Pressure

Context

Maintaining proper pressure inside a spacesuit is essential to astronaut survival during a spacewalk. A lack of pressure will cause body fluids to turn to gas, and resulting in death in a few seconds. While making spacewalks possible, pressure produces its own problems. An inflated spacesuit can be very difficult to bend. In essence, a spacesuit is a balloon with an astronaut inside. The rubber of the balloon keeps in oxygen that is delivered to the suit from pressurized oxygen tanks in the backpack. But, as pressure inside the balloon builds up, the balloon's walls become stiff, making normal bending motions impossible. Lack of flexibility defeats the purpose of the spacewalk—mobility and the ability to do work in space.

Spacesuit designers have learned that strategically placed breaking points at appropriate locations outside the pressure bladder (the balloon-like layer inside a spacesuit) makes the suit become more bendable. The breaking points help form joints that bend more easily than unjointed materials. Other techniques for promoting bending include stitching folds into the restraint layer that spread apart and

contract with bending and building joints into the restraint layer like ribs on vacuum cleaner hoses.

Objective

- To observe how an external joint in a spacesuit arm segment increases bendability of the segment.

Materials and Tools Checklist

Two long balloons

3 heavy-duty rubber bands

Procedure

Step 1. Inflate a long balloon and tie it off. The balloon represents the pressure bladder of a spacesuit arm.

Let students try to bend the balloon in the middle.

Step 2. Inflate a second long balloon. As you are inflating the balloon, slip heavy-duty rubber bands over the balloon at intervals so that as inflation continues the balloon is pinched by the rubber bands. It is easier to accomplish this by pre-inflating the balloon. It may be necessary to double the rubber band to pinch the balloon enough for the demonstration. Have students compare the force required for bending this balloon with the force needed for the first balloon.



Extensions

- Compare the stiffness of the balloons to other inflated structures such as air mattresses, inner tubes, beach balls, etc.
- Use a Slinky® as an alternative to the rubber bands. Place the Slinky® on a desk top and pick up one end. Slip in the balloon and inflate it. As the balloon inflates, it will be pinched in a spiral pattern by the Slinky®. The pattern will achieve the same result as the rubber bands.

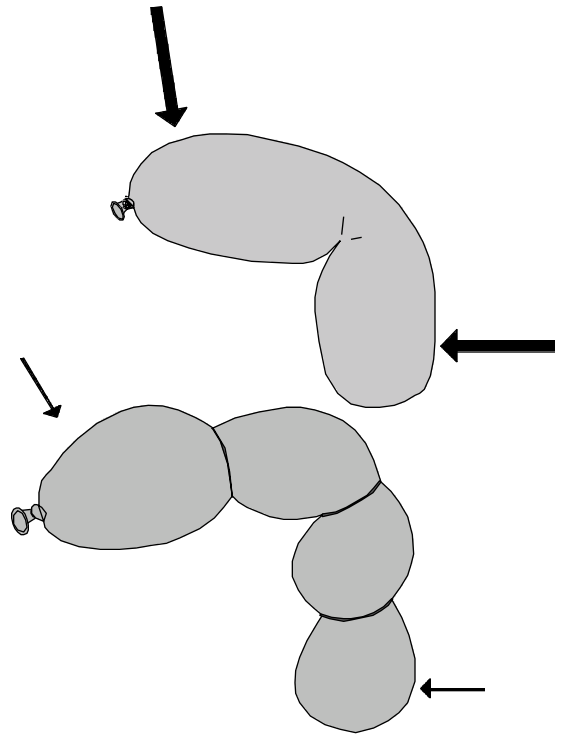
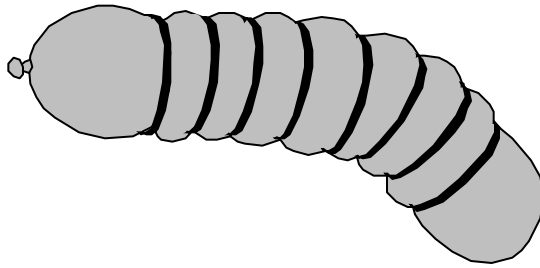

Idea Bank

Use these ideas as suggestions for additional testing and measurement apparatus and for techniques that could be employed for constructing suit parts.

1. Suit Arm and Leg Bending Tester

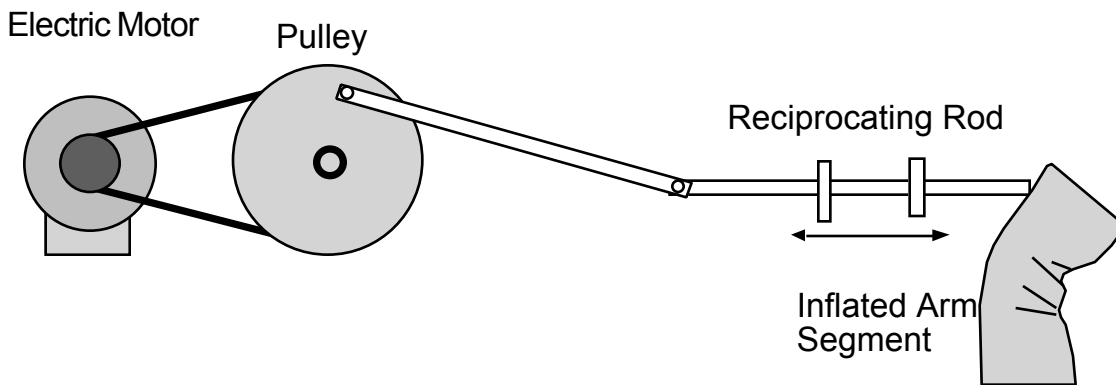

2. Tethers

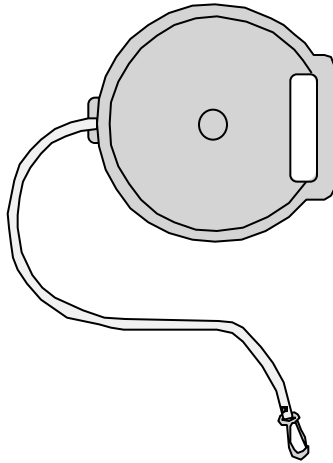

3. Field of Vision Tester for Helmet Vision Design
Determine how much visibility is needed for a space suit helmet by measuring the field of vision of students. Two different ways for doing this are shown.

Test for Right and Left Views

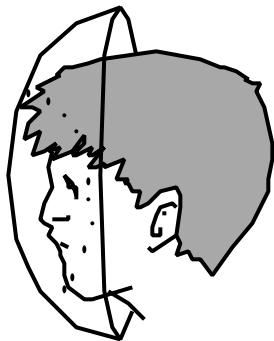
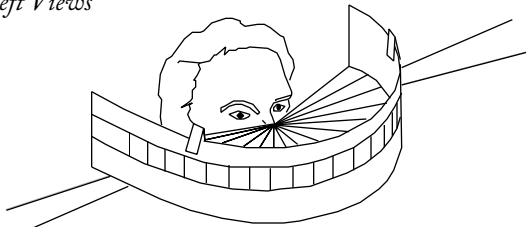

Omnidirectional test. Use clear plastic punch bowl and place dots at limit of vision.

4. Connector Seal Test

Place Martian sediment simulant or other dry sandy sediment in the jar. Place plastic tape over the zone where the lid comes together with the jar. Shake the jar several hundred times and then remove the tape to see if any sediment made its way through the jar and lid threads to stick to the tape.

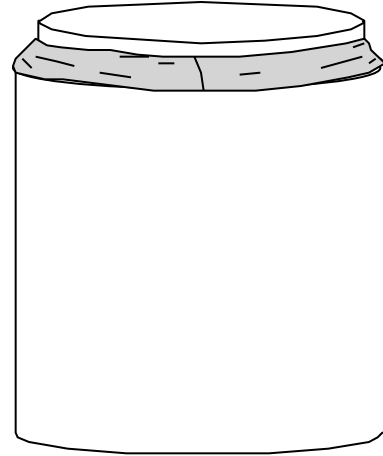

5. Weightlifting

Research an exercise routine that can be used to strengthen the upper body. This is the area of the body that receives the greatest workout during a spacewalk in Earth orbit. Design exercises for strengthening the lower torso and for planetary surface exploration.

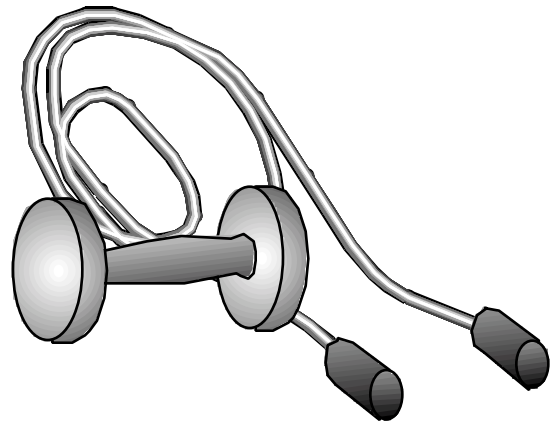

6. Measurements for Space Helmet

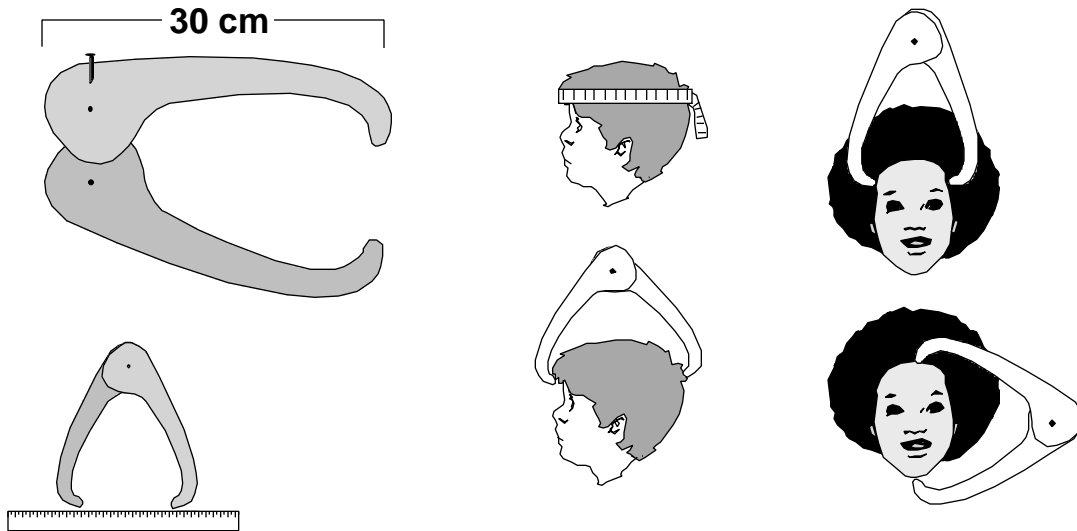

7. Paper Maché Space Helmet

Inflate a large round balloon to a diameter greater than student heads. Cover the balloon with four layers of paper maché. Paper maché can be made with newspaper strips and a 50/50 solution of white

glue and water or with premixed wallpaper paste. Let each layer dry before applying the next one. When completely dry, deflate and remove the balloon and cut appropriate holes with a scissors. Paint as desired.

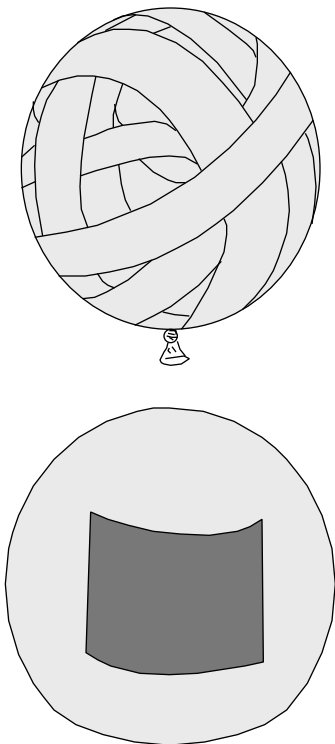

8. Visor Light Transmission Tester

Connect a solar cell to a potentiometer and a millimeter. These items are available from an electronic parts store. Adjust the potentiometer so a light source you are measuring does not drive the needle off the scale. Place potential space helmet visor material between the light source and the solar cell to evaluate the material's light-filtering properties.

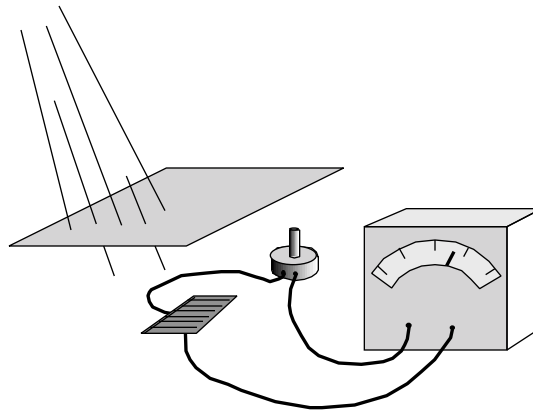

9. Vacuum Experiment - 1

Obtain an electric doorbell, push button, and doorbell transformer. Insert the wires to the doorbell through a single-hole rubber stopper. The stopper should fit the upper hole in the bell jar. Fill the rest of the stopper hole with hot glue from a hot-glue gun to seal the wires in place. Evacuate the bell jar and ring the doorbell. While holding the button, gradually let air back into the jar. The bell cannot be heard ringing when the jar is evacuated even though the clapper can be seen to be moving. This demonstration explains why spacesuits have 2-way radios. Sound is not conducted through a vacuum.

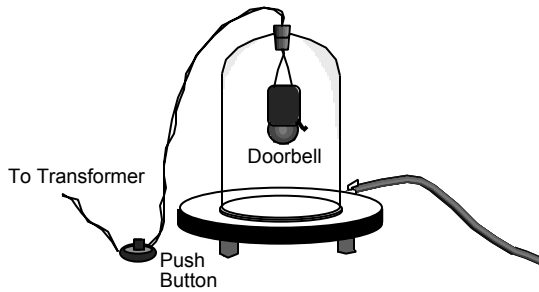

10. Vacuum Experiment - 2

Show how fluids like water boil when they are exposed to a vacuum. Place water in a beaker and evacuate the bell jar. The demonstration will take place more rapidly if warm water is used. Place a thermometer in the beaker to record the boiling temperature.

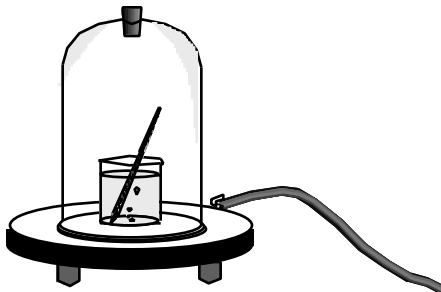

11. Vacuum Experiment - 3

Construct a marshmallow astronaut out of regular size and mini marshmallows and toothpicks. Evacuate the bell jar and observe how the marshmallows expand. Living tissue will also inflate in a vacuum because of gas bubbles forming in the fluids of cells.

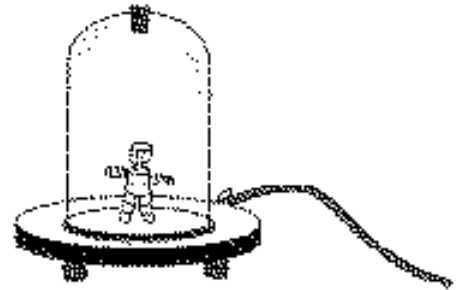

Note: The vacuum pump, vacuum plate, and bell jar needed for the activities on this page are common pieces of science equipment found in many junior and senior high schools. This equipment is available from school science supply catalogs.

12. Underwater Training

If a swimming pool is available, practice underwater EVA training. Have students wear a dive mask

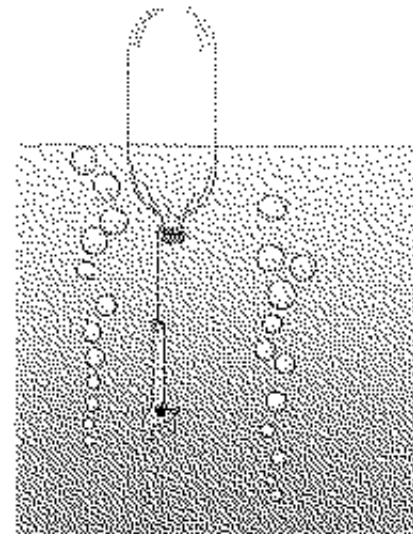

and assemble PVC water pipe parts underwater. Make a weighted panel that has bolts protruding from it. Use a chrome steel wrench to try to turn the bolts while free floating in the water. Make tools appear weightless by attaching a string to the handles and to empty two liter soft drink bottles. Invite a local SCUBA shop to participate in the activity. The shop owners might be willing to supply dive equipment and serve as safety divers during the simulation.

13. Design A Tool

Have students design and construct a prototype multipurpose tool for use on spacewalks. The tool should combine the functions of single purpose tools such as hammers, screw drivers, wrenches, etc. The tool should also make provisions for attachment to tethers and easy gripping.

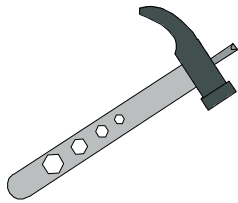

14. Torque

Place a student on a swivel office chair or on a rotating platform like a child's Sit and Spin®. Have two other students hold a 2 by 4, with a bolt par-

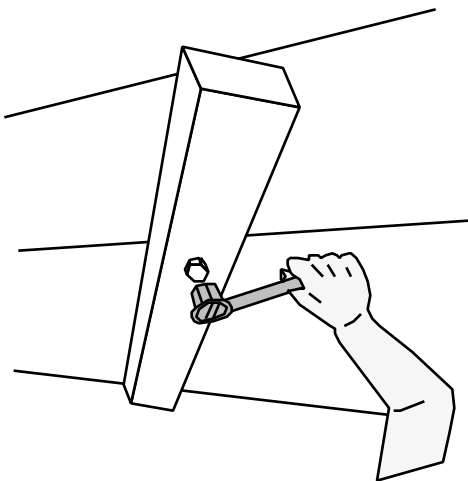

tially screwed into it, over the first student. The first student will find it difficult to turn the bolt with a wrench without spinning as well. Relate this to the challenges astronauts have on spacewalks when they try to do a similar job. To turn a bolt or move some massive object in space, an astronaut is attached to a stable work platform.

15. Glove Work

Use rubber-coated work gloves from a hardware store to demonstrate the importance of spacesuit gloves that are comfortable to wear. Have students attempt to screw a bolt into a nut or assemble plastic snap toys into a structure. Discuss how these gloves can be improved to make them easier to use.



16. Neutral Buoyancy

Astronauts simulate microgravity for spacesuit training in a deep swimming pool. Their spacesuits are specially weighted to produce neutral buoyancy.

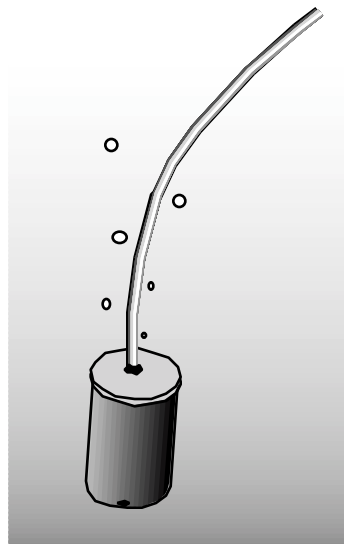

You can investigate neutral buoyancy by creating a small submarine out of a plastic film canister, aquarium tubing, pennies, and hot glue. Punch two holes at the base of the canister and a hole in the lid. Hot glue the end of the aquarium tube into the hole in the lid. Add several pennies to the canister so that when you place it in a water-filled aquarium, the canister just floats. Suck air out of the tube to cause the canister to sink. Try to get the canister to hover half way from the bottom to the surface.

17. Neutral Buoyancy - 2

Neutral buoyancy can also be investigated with a Cartesian diver. Fill a plastic soft drink bottle with water. Insert an eyedropper that is partially filled with water. Cap the bottle and squeeze the bottle's sides to increase the pressure in the bottle. The trapped air in the eyedropper will compress and the eye dropper will sink. Try to get the eyedropper to hover midway in the bottle.

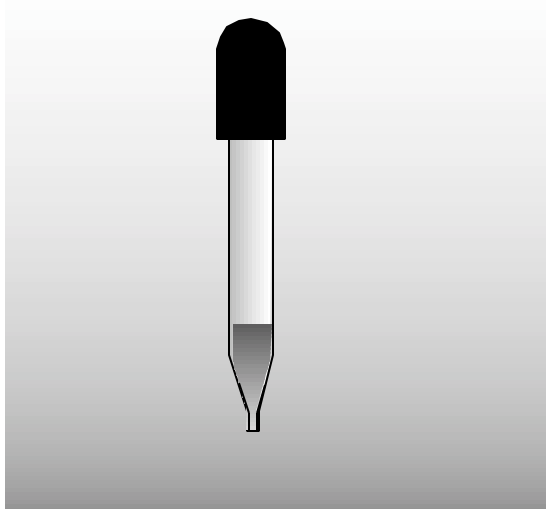

Glossary

AMU	Astronaut Maneuvering Unit
Apollo	NASA project that landed astronauts on the Moon
CCA	Communications Carrier Assembly
CCC	Contaminant Control Cartridge
Composite Material	Substance derived by combining two or more materials such as glass fibers and epoxy
DCM	Displays and Control Module
EEH	EMU Electrical Harness
EMU	Extravehicular Mobility Unit
EVA	Extravehicular Activity; Extravehicular Visor Assembly
Gemini	NASA project that pioneered space flight technologies for spacecraft rendezvous and docking and spacewalking
HHMU	Hand-Held Maneuvering Unit
HUT	Hard Upper Torso
IDB	In-Suit Drink Bag
ISS	International Space Station
Joule	One newton meter or $1 \text{ kg} \cdot \text{m}^2/\text{s}^2$
Kilopascal	Metric pressure unit; one pound per square inch pressure equals 6.895 kilopascals
Kinetic Energy	Energy in motion
LCVG	Liquid Cooling-and-Ventilation Garment
MAG	Maximum Absorption Garment
Microgravity	An environment, produced by free-fall, that alters the local effects of gravity and makes objects seem weightless
Micrometeoroid	Tiny particle of space debris (natural or artificial) traveling at high speed through space



MMU	Manned Maneuvering Unit
Mercury	The NASA project that launched the first U.S. astronauts into space and demonstrated that humans could live and work in space
ORU	Orbital replacement unit
PLSS	Primary Life-Support System
Regolith	Sediment derived directly from igneous rock and not containing any organically-derived materials
RMS	Remote Manipulator System
SCU	Service and Cooling Umbilical
Skylab	First U.S. space station
SOP	Secondary Oxygen Pack
SAFER	Self-rescue rocket backpack device for use during spacewalks around the International Space Station
Space Shuttle	Reusable spaceship currently used for all U.S. manned space missions
Spacewalk	Extravehicular activity
Sublimation	Change of state of matter from a solid to a gas



References

- Allen, J.P. with Martin, M. (1984), *Entering Space, An Astronaut's Odyssey*, Stewart, Tabori & Chang, New York City, NY.
- Compton, W. & Bensen, C. (1983), *Living and Working In Space, A History of Skylab*, NASA SP-4208, Scientific and Technical Information Branch, NASA Headquarters, Washington, DC.
- Kozloski, L. (1994), *U.S. Space Gear, Outfitting The Astronaut*, Smithsonian Institution Press, Washington, DC.
- Kuznik, F. (1997), *Spacesuit Saga: A Story in Many Parts*, Air & Space, V12N3.
- Machell, R. ed. (1967), *Summary of Gemini Extravehicular Activity*, NASA SP-149, Scientific and Technical Information Division, Office of Technology Utilization, NASA Headquarters, Washington, DC.
- Mohler, S.R. & Johnson, B.H. (1971), *Wiley Post, His Winnie Mae, and the World's First Pressure Suit*, Smithsonian Institution Press, Washington, DC.
- NASA (1973), *Apollo*, EP-100, NASA Headquarters, Washington, DC.
- NASA (1991), *Go For EVA, Liftoff to Learning Series*. (Videotape), Education Working Group, NASA Johnson Space Center, Houston, TX.
- NASA (1987), *The Early Years: Mercury to Apollo-Soyuz*, Information Summaries, PMS 001-A, NASA Kennedy Space Center, FL.
- NASA (1970), *The First Lunar Landing As Told by The Astronauts*, EP-73, NASA Headquarters, Washington, DC.
- Vogt, G. (1987), *Spacewalking*, Franklin Watts, New York City, NY.
- Vogt, G., Rodgers, M. and Wargo, M. (1997), *Microgravity - A Teacher's Guide With Activities, Secondary Level*, EG-1997-08-110-HQ, NASA Headquarters, Washington, DC.



NASA Resources for Educators

NASA's Central Operation of Resources for Educators (CORE) was established for the national and international distribution of NASA-produced educational materials in audiovisual format. Educators can obtain a catalogue and an order form by one of the following methods:

- NASA CORE
Lorain County Joint Vocational School
15181 Route 58 South
Oberlin, OH 44074
- Phone (440) 774-1051, Ext.249 or 293
- Fax (440) 774-2144
- E-mail nasaco@leeca8.esu.k12.oh.us
- Home Page: <http://spacelink.nasa.gov/CORE>

Educator Resource Center Network

To make additional information available to the education community, the NASA Education Division has created the NASA Educator Resource Center (ERC) network. ERCs contain a wealth of information for educators: publications, reference books, slide sets, audio cassettes, videotapes, telelecture programs, computer programs, lesson plans, and teacher guides with activities. Educators may preview, copy, or receive NASA materials at these sites. Because each NASA Field Center has its own areas of expertise, no two ERCs are exactly alike. Phone calls are welcome if you are unable to visit the ERC that serves your geographic area. A list of the centers and the regions they serve includes:

*AK, AZ, CA, HI, ID, MT, NV, OR, UT,
WA, WY*
NASA Educator Resource Center
Mail Stop 253-2
NASA Ames Research Center
Moffett Field, CA 94035-1000
Phone: (415) 604-3574

*CT, DE, DC, ME, MD, MA, NH, NJ, NY,
PA, RI, VT*
NASA Educator Resource Laboratory
Mail Code 130.3
NASA Goddard Space Flight Center
Greenbelt, MD 20771-0001
Phone: (301) 286-8570

CO, KS, NE, NM, ND, OK, SD, TX
JSC Educator Resource Center
Space Center Houston
NASA Johnson Space Center
1601 NASA Road One
Houston, TX 77058-3696
Phone: (281) 483-8696

FL, GA, PR, VI
NASA Educator Resource Laboratory
Mail Code ERL
NASA Kennedy Space Center
Kennedy Space Center, FL 32899-0001
Phone: (407) 867-4090

KY, NC, SC, VA, WV
Virginia Air and Space Museum
NASA Educator Resource Center for
NASA Langley Research Center
600 Settlers Landing Road
Hampton, VA 23669-4033
Phone: (757) 727-0900 x 757

IL, IN, MI, MN, OH, WI
NASA Educator Resource Center
Mail Stop 8-1
NASA Lewis Research Center
21000 Brookpark Road
Cleveland, OH 44135-3191
Phone: (216) 433-2017

AL, AR, LA, LA, MO, TN
U.S. Space and Rocket Center
NASA Educator Resource Center for
NASA Marshall Space Flight Center
P.O. Box 070015
Huntsville, AL 35807-7015
Phone: (205) 544-5812

MS
NASA Educator Resource Center
Building 1200
NASA John C. Stennis Space Center
Stennis Space Center, MS 39529-6000
Phone: (601) 688-3338

NASA Educator Resource Center
JPL Educational Outreach
Mail Stop CS-530
NASA Jet Propulsion Laboratory
4800 Oak Grove Drive
Pasadena, CA 91109-8099
Phone: (818) 354-6916

CA cities near the Center
NASA Educator Resource Center for
NASA Dryden Flight Research Center
45108 N. 3rd Street East
Lancaster, CA 93535
Phone: (805) 948-7347

VA and MD's Eastern Shores
NASA Educator Resource Lab
Education Complex - Visitor Center
Building J-1
NASA Wallops Flight Facility
Wallops Island, VA 23337-5099
Phone: (757) 824-2297/2298

Regional Educator Resource Centers offer more educators access to NASA educational materials. NASA has formed partnerships with universities, museums, and other educational institutions to serve as regional ERCs in many states. A complete list of regional ERCs is available through CORE, or electronically via the NASA Education Home Page at: <http://www.hq.nasa.gov/education>

NASA On-line Resources for Educators provide current educational information and instructional resource materials to teachers, faculty, and students. A wide range of information is available, including science, mathematics, engineering, and technology education lesson plans, historical information related to the aeronautics and space program, current status reports on NASA projects, news releases, information on NASA educational programs, useful software and graphics files. Educators and students can also use NASA resources as learning tools to explore the Internet, accessing information about educational grants, interacting with other schools which are already on-line, and participating in on-line interactive projects, communicating with NASA scientists, engineers, and other team members to experience the excitement of real NASA projects.

Access these resources through the NASA Education Home Page: <http://www.hq.nasa.gov/education>

NASA Television (NTV) is the Agency's distribution system for live and taped programs. It offers the public a front-row seat for launches and missions, as well as informational and educational programming, historical documentaries, and updates on the latest developments in aeronautics and space science. NTV is transmitted on the GE-2 satellite, Transponder 9C at 85 degrees West longitude, vertical polarization, with a frequency of 3880 megahertz, and audio of 6.8 megahertz.

Apart from live mission coverage, regular NASA Television programming includes a Video File from noon to 1:00 pm, a NASA Gallery File from 1:00 to 2:00 pm, and an Education File from 2:00 to 3:00 pm (all times Eastern). This sequence is repeated at 3:00 pm, 6:00 pm, and 9:00 pm, Monday through Friday. The NTV Education File features programming for teachers and students on science, mathematics, and technology. NASA Television programming may be videotaped for later use.

For more information on NASA Television, contact:
NASA Headquarters, Code P-2, NASA TV, Washington, DC 20546-0001 Phone: (202) 358-3572
NTV Home Page: <http://www.hq.nasa.gov/ntv.html>

How to Access NASA's Education Materials and Services, EP-1996-11-345-HQ

This brochure serves as a guide to accessing a variety of NASA materials and services for educators. Copies are available through the ERC network, or electronically via NASA Spacelink. NASA Spacelink can be accessed at the following address: <http://spacelink.nasa.gov>



Grade Level	Application
K-8	Technology Education, Life Sciences, Physical Science, History

Go For EVA!

Educational Videotape Series



Image from the videotape *Go for EVA!* of the *Liftoff To Learning* Videotape Series.

Go For EVA! is from the *Liftoff to Learning Educational Videotape Series*, which allows students to study science, mathematics, and technology with crew members aboard Space Shuttle flights.

Go For EVA! discusses how spacesuits protect astronauts from the hostile space environment, explains what the components of the spacesuit are, describes how the suit functions, and shows what types of work astronauts perform while spacewalking. Actual footage of spacewalks—also known as Extravehicular Activities (EVAs)—illustrate how spacesuits allow astronauts to operate scientific apparatus, assemble equipment and structures, pilot the Manned Maneuvering Unit, take pictures, and service satellites and space hardware.

Length: 13:48

To obtain a copy of the *Go For EVA!* videotape and accompanying Video Resource Guide, or for more information on the *Liftoff to Learning Educational Videotape Series*, contact your local Educator Resource Center or the NASA Central Operation of Resources for Educators (CORE). See page 99 for details.



Suited for Spacewalking

A Teacher's Guide with Activities for Technology Education, Mathematics, and Science

TEACHER REPLY CARD

To achieve America's goals in Educational Excellence, it is NASA's mission to develop supplementary instructional materials and curricula in science, mathematics, and technology. NASA seeks to involve the educational community in the development and improvement of these materials. Your evaluation and suggestions are vital to continually improving NASA educational materials.

Please take a moment to respond to the statements and questions below. You can submit your response through the Internet or by mail. Send your reply to the following Internet address:

http://ednet.gsfc.nasa.gov/edcats/teacher_guide

You will then be asked to enter your data at the appropriate prompt.

Otherwise, please return the reply card by mail. Thank you.

1. With what grades did you use the guide?

Number of **Teachers/Faculty**:

- K-4 Community College
 5-8 College/University - Undergraduate
 9-12 College/University - Graduate

Number of **Students**:

- K-4 Community College
 5-8 College/University - Undergraduate
 9-12 College/University - Graduate

Number of **Others**:

- Administrators/Staff Professional Groups
 Parents Civic Groups
 General Public Other _____

2. What is your home 5- or 9-digit zip code? _____

3. How was the quality of this video guide?

- Excellent Good Average Poor Very Poor

4. How did you use this guide?

- | | |
|---|--|
| <input type="radio"/> Background Information | <input type="radio"/> Critical Thinking Tasks |
| <input type="radio"/> Demonstrate NASA Materials | <input type="radio"/> Demonstration |
| <input type="radio"/> Group Discussions | <input type="radio"/> Hands-On Activities |
| <input type="radio"/> Integration Into Existing Curricula | <input type="radio"/> Interdisciplinary Activity |
| <input type="radio"/> Lecture | <input type="radio"/> Science and Mathematics |
| <input type="radio"/> Team Activities | <input type="radio"/> Standards Integration |
| <input type="radio"/> Other: Please specify: _____ | |

5. Where did you learn about this guide?

- NASA Central Operation of Resources for Educators (CORE)
 NASA Educator Resource Center
 Institution/School System
 Fellow Educator
 Workshop/Conference
 Other: Please specify: _____

6. What features of this guide did you find particularly helpful?

7. How can we make this guide more effective for you?

8. Additional comments:

Today's Date: _____

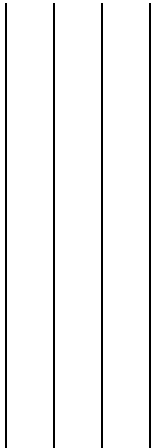

Please Place
Stamp Here
Post Office
Will Not Deliver
Without Proper
Postage

**NATIONAL AERONAUTICS AND SPACE ADMINISTRATION
EDUCATION DIVISION
CODE FE
WASHINGTON DC 20546-0001**

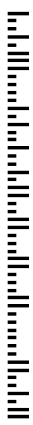

Fold along line and tape closed.